



HEWLETT
PACKARD

Interfacing
and
Programming
Manual

HP 7475A
Graphics Plotter

MASTER
COPY

Chapter 1

Getting Started

What You'll Learn in This Chapter

This chapter explains how to use this manual and other manuals you may need or find useful. In addition, this chapter describes:

- The 7475 Graphics Plotter's features
- Its two interfaces
- The plotter's language and syntax
- Four instructions from the plotter's language, HP-GL (Hewlett-Packard Graphics Language).

HP-GL Instructions Covered

- DF The Default Instruction
- IN The Initialize Instruction
- IM The Input Mask Instruction
- PS The Paper Size Instruction

Terms You Should Understand

HP-GL — Hewlett-Packard Graphics Language — the two-letter mnemonic graphics language understood by the 7475 plotter and other HP graphics devices. The instruction's mnemonic is suggestive of its role. For example, PA is used to plot to absolute coordinates, SP is used to select a pen, and DR is used to establish the relative direction of labeling.

HP-IB — Hewlett-Packard Interface Bus — HP's implementation of the IEEE standard 488-1978 digital interface for programmable instrumentation is commonly found on HP desktop computers and some larger computers. The HP-IB interface is standard on the Option 002 plotter.

RS-232-C/CCITT V.24 Interface — another popular standardized interface. It is commonly found on large computers, personal computers, and where communication between a terminal and a computer over telephone lines is required. This interface is standard on the Option 001 plotter.

How to Use HP 7475 Documentation

This manual contains interfacing and programming information for the HP 7475 Plotter and its interfacing options. The Option 001 plotter is equipped with the RS-232-C/CCITT V.24 Interface. The Option 002 plotter is interfaced through the Hewlett-Packard Interface Bus (HP-IB) which conforms to ANSI/IEEE 488-1978 specifications. All interfaces use the Hewlett-Packard Graphics Language (HP-GL) for control of plotter graphics capabilities. Unless specifically noted, all information in this manual pertains to all configurations.

NOTE: All information in this manual for Option 001 plotters applies equally to RS-232-C and CCITT V.24 interfaces. For purposes of simplicity, both are referred to as RS-232-C. ■

Documentation for this plotter is designed so that you can use the plotter easily. All plotters are shipped with this manual, an Operation and Interconnection Manual (Part No. 07475-90002), and a Reference Card (07475-90004). The Operation and Interconnection Manual contains all the information you will need to physically connect your plotter to certain computers, and to verify that the connection has been made. It also contains information on how to operate, but not program, your plotter. The Reference Card lists the plotter's HP-GL instructions with their parameters, its device control instructions for the RS-232-C version, and the error numbers and their meanings.

For First Encounters with the 7475

If you have just received your HP 7475, read the Operation and Interconnection Manual before attempting to operate the plotter. After inspecting your plotter, its power cord, and accessories as described in the Operation and Interconnection Manual, refer to the appropriate chapter of this manual for initial setup and addressing or handshaking protocol for your configuration. RS-232-C users should read Chapter 10, and HP-IB users should read Chapter 9.

For First Encounters with HP-GL

If you have never programmed in HP-GL, after reading the interfacing chapter, read Chapters 1 through 5 in order. These chapters describe the instructions you will use in almost every application. Be sure you run the examples given with the instructions, as this will help you learn HP-GL. Next, read Chapter 8 to see how all the instructions work together in a program. When you have an application requiring digitizing or plotter output, read Chapters 6 and 7.

For Experienced HP-GL Programmers

If you are an experienced HP-GL programmer, you may find Appendix B of this manual or the Reference Card most helpful. Since there are differences in syntax between this and other plotters, you should read Chapter 1 of this manual before programming. The 7475 has added capabilities not found in earlier plotters. Among these are the ability to plot to non-integer user-unit values, to mirror labels using negative size and direction parameters, to output the current window values, and to rotate the plotter unit and user-unit coordinate systems 90 degrees. To understand these differences, you need to read the sections on scaling (SC, Chapter 2), rotation (RO, Chapter 2), plotting (PA and PR, Chapter 3), and setting label size and direction (DR, DI, SR, and SI, Chapter 5). In the instruction set summary in Appendix B, page numbers for the complete description are listed with each instruction.

Understanding Manual Conventions and Syntax

Before reading any part of this manual, you should understand the meaning of type styles, symbols, and number representation used in text. A detailed explanation of syntax symbols is given in the section entitled HP-GL Syntax in this chapter and Instruction Syntax for Device Control Instructions in Chapter 10. The following conventions also apply. Words typed in small **boldface** type are either buttons, switches, or words actually found on the plotter or computer. Headings in **REVERSE** type are used to help locate specific parts of the writeup of an instruction. **REVERSE** type in a smaller size is used to denote a single ASCII character which should be sent to the plotter. Numbers are typed using SI (International System of Units) standards; numbers with more than four digits are placed in groups of three, separated by a space instead of commas, counting both to the left and right of the decimal point (54 321.123 45).

Follow the documentation road map below:

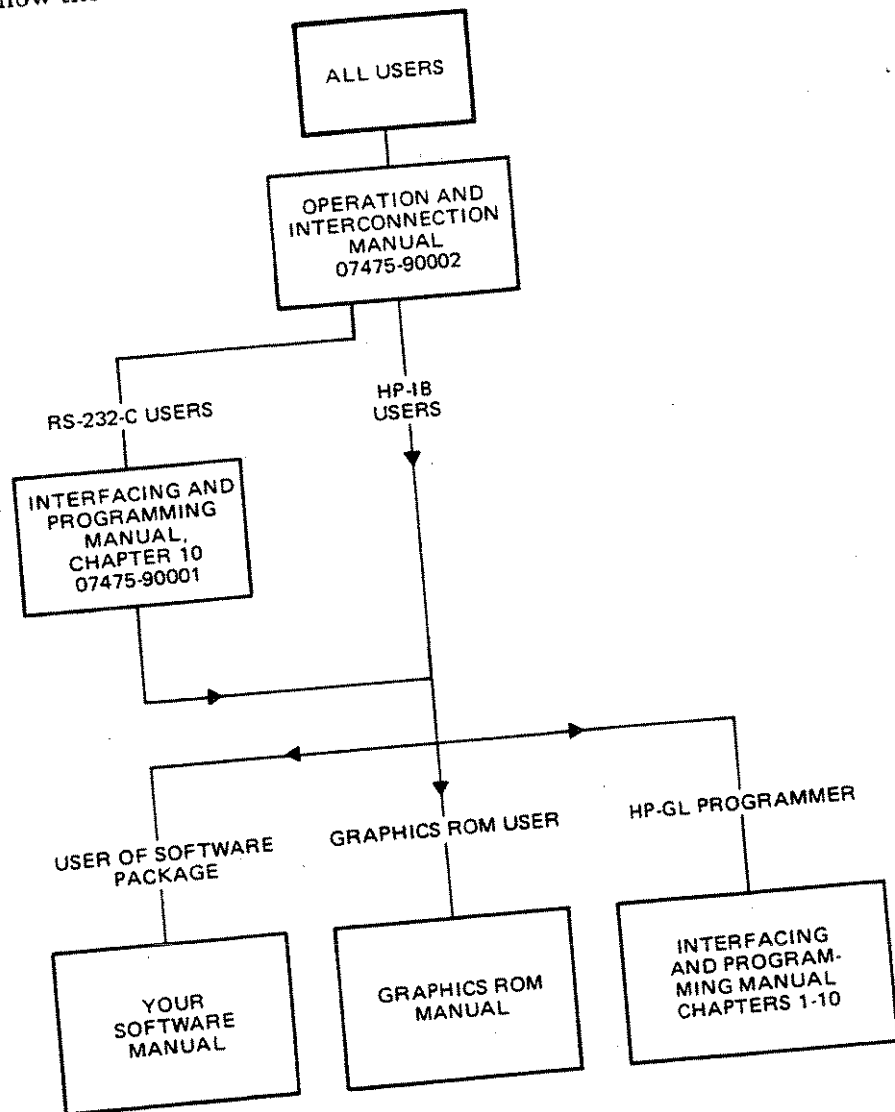

A Brief Look at the 7475 Plotter

The HP 7475 Graphics Plotter is a vector plotter which produces high quality, multicolor graphics plots on four sizes of drawing media:

ISO A4 (210 × 297 mm)

ISO A3 (297 × 420 mm)

ANSI A (8½ × 11 in.)

ANSI B (11 × 17 in.)

The 7475 can produce distinctive graphics not only on standard paper, but also on other media such as transparency film. The plotter offers both high plotting speed and excellent line quality, using Hewlett-Packard's paper-moving technology. This technology uses low-inertia, grit-covered wheels to move the paper in one axis while the pen moves along the other axis. The 7475 plots with approximately 2 g acceleration and a maximum velocity of 38.1 cm/s (15 in./s). The result is exceptional line and character quality and high throughput. The 7475 has an addressable resolution of 0.025 mm (0.00098 in.) and a repeatability of 0.10 mm (0.004 in.) for any given pen.

On your 7475, you can produce multicolor graphics by programmed or front-panel selection of six pens. If you desire additional colors, you can stop the program and manually install additional pens. Symbol-mode plotting and seven different dashed-line fonts provide additional trace identification capabilities.

Using character plotting speeds of up to two characters per second, you can produce fully-labeled graphs quickly. Using any of 19 character sets, you can readily annotate your graph with text in any direction, with or without character slant, and in varying sizes. Finally, with the area fill instructions, you can easily fill segments of a pie chart or rectangle.

The 7475 is engineered to be especially useful in the areas of business graphics, statistics, medicine, numerical control, surveying, and engineering design. With an optional overhead transparency kit, you can produce high quality graphic transparencies from your plotting programs. For faster comprehension, you can present economic trends, engineering or scientific data, marketing plans, profit data, or sales forecasts pictorially. And with this choice of media, you can create paper hardcopy for an individual's attention or transparencies for group presentations.

Whether you tabulate, measure, or compute data, depend on the reliable 7475 to prepare multicolored plots of excellent line quality and high resolution.

The 7475 Plotter's Instruction Set

Both interface configurations for the HP 7475 plotter use the same Hewlett-Packard Graphics Language (HP-GL) instruction set. HP-GL consists of two-letter mnemonic instructions which activate the plotter. A table listing the instructions alphabetically is located at the end of the next section. Syntax descriptions and explanations of these instructions are contained in Chapters 1 through 8. Six additional HP-GL instructions cause no operation but are included for compatibility with other HP plotters. These instructions are listed in Appendix C.

Fourteen additional instructions, called device control instructions, are required by the RS-232-C configuration. These instructions are used to establish plotter output and handshake protocol, and to control conditions which are pertinent only to the RS-232-C environment. In an RS-232-C plotter, all HP-GL instructions enter the plotter's internal buffer and are executed in a first-in, first-out sequence. All device control instructions, except **ESC**.L, do not enter the buffer, but instead are executed immediately upon receipt. Refer to Chapter 10 for the syntax description and an explanation of the device control instructions.

HP-GL Syntax

An HP-GL instruction is a two-letter mnemonic followed by its parameter field, if any, and a terminator. If parameters follow the mnemonic, they must be separated from each other by at least one comma or space, or by a + or - sign which may be preceded by commas or spaces. Optional commas and/or spaces may be used as separators before, after, and between the mnemonic and before the terminator. An instruction is terminated by a semicolon or by the next mnemonic. If you have an HP-IB plotter, a line feed can also terminate an instruction. (Note that if you have an RS-232-C plotter, a line feed is **not** a valid terminator.) All instructions will execute immediately after the mnemonic or last possible parameter is received. If too many parameters are sent, the instruction will be executed with the required number of parameters and error 2 is set (wrong number of parameters). The syntax is shown below.

NOTE: This syntax is true for every instruction except the SM and DT instructions. These instructions will interpret the first character after the mnemonic as the symbol or label terminator, respectively. ■

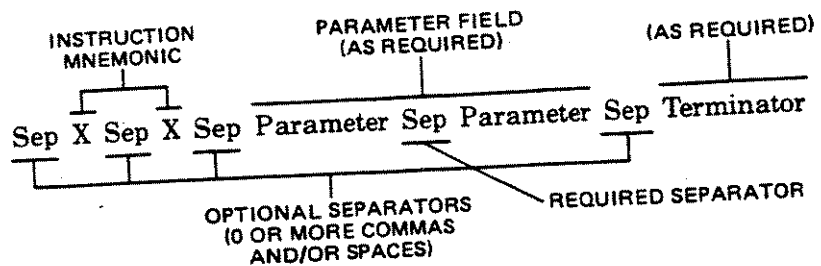

NOTE: The syntax used on the 7475 is extremely flexible and differs from the HP 9872. Therefore, any software written for the 7475 which takes advantage of its less rigorous syntax may not drive other HP plotters. If software is to be used with other HP-GL plotters, the more rigorous syntax of the HP 9872 plotter should be used.

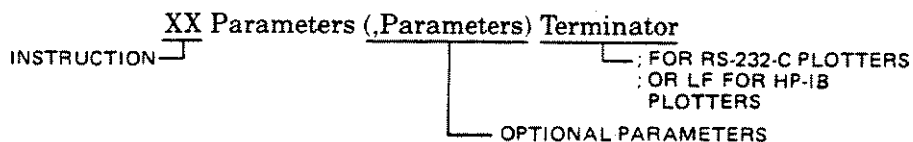

The 9872 syntax does not allow separators between the characters of the mnemonic. One comma must separate parameters. Only ; or LF may be used as the terminator for HP-IB plotters, and only ; may be used as the terminator for RS-232-C plotters. In addition, parameters requiring integer format may not contain a decimal point or decimal fraction. ■

Some instructions have optional parameters which, when omitted, assume a default value. To omit a parameter, all subsequent parameters in the same instruction must be omitted. The exceptions to this rule are the parameters of the FT and UC instructions.

The label instruction, LB, is a special case; it must be terminated with the label terminator character. This character defaults to the ASCII end-of-text character, ETX, whose decimal equivalent is 3. The label terminator may be changed from its default value using the define terminator instruction, DT.

The parameter fields must be specified in the format defined by the syntax of each respective HP-GL instruction. The format can be of four types:

1. Integer Format — a parameter in integer format between -32 768 and +32 767. Decimal fractions of parameters which must be integers are truncated. If no sign is specified, the parameter is assumed to be positive.
2. Decimal Format — a number between -128.0000 and 127.9999 with an optional decimal point and decimal fraction with up to four significant digits. If no sign is specified, the parameter is assumed to be positive.
3. Scaled decimal format — a number between -32 768.0000 and +32 767.9999 with an optional decimal point and decimal fraction with up to four significant digits. If no sign is specified, the parameter is assumed to be positive.

NOTE: Scaled decimal format is used only when user-unit scaling is active. This format applies to all HP-GL instruction parameters that are interpreted as user-units. ■

4. Label Fields — any combination of text, numeric expressions, or string variables. Refer to The Label Instruction, LB, Chapter 5, for a complete description.

Some instructions such as PA, PR, PU, and PD may have multiple parameters. Separators are required between these parameters. These optional parameters are shown in parentheses in the syntax descriptions.

The syntax shown under the description of each HP-GL instruction uses the following notations:

- MN*emonic For readability, the mnemonic is shown upper-case and separated from the parameters and/or terminator.
- necessary parameter All typeset items are required parameters.
- () All items in parentheses are optional.
- c...c Any number of labeling characters.
- (,...) Any number of X,Y coordinate pairs.
- terminator ; or the next mnemonic. LF is also valid for the HP-IB plotters. An instruction followed by a parameter must include a terminator.

The following table shows the 7475's HP-GL instruction set.

Plotter Instruction Set

| Instruction | Description |
|--|---------------------------|
| AA X [i/sd], Y [i/sd], arc angle [i] (,chord angle [i]) | Arc absolute |
| AR X [i/sd], Y [i/sd], arc angle [i] (,chord angle [i]) | Arc relative |
| CA n [i] | Designate alternate set n |
| CI radius [i/sd] (,chord angle [i]) | Circle |
| CP spaces [d], lines [d] | Character plot |
| CS n [i] | Designate standard set n |
| DC | Digitize clear |
| DF | Set default values |
| DI run [d], rise [d] | Absolute direction |
| DP | Digitize point |
| DR run [d], rise [d] | Relative direction |
| DT c [c] | Define label terminator |
| EA X [i/sd], Y [i/sd] | Edge rectangle absolute |
| ER X [i/sd], Y [i/sd] | Edge rectangle relative |
| EW radius [i/sd], start angle [i], sweep angle [i] (,chord angle [i]) | Edge wedge |

Plotter Instruction Set (Continued)

| Instruction | Description |
|---|--|
| FT type [i] (,spacing [sd] (,angle [i])) | Fill type |
| IM e [i] (,s [i] (,p [i])) | Input e, s, and p masks |
| IN | Initialize |
| IP P1 _x [i], P1 _y [i] (,P2 _x [i], P2 _y [i]) | Input P1 and P2 |
| IW X _{lo} [i], Y _{lo} [i], X _{hi} [i], Y _{hi} [i] | Input window |
| LB c . . . c [c] | Label ASCII string |
| LT t [d] (,l [d]) | Designate line type and length |
| OA [i return] | Output actual position and pen status |
| OC [i/sd return] | Output commanded position and pen status |
| OD [i return] | Output digitized point and pen status |
| OE [i return] | Output error |
| OF [i return] | Output factors |
| OH [i return] | Output hard-clip limits |
| OI [c return] | Output identification |
| OO [i return] | Output options |
| OP [i return] | Output P1 and P2 |
| OS [i return] | Output status |
| OW [i return] | Output window |
| PA X [i/sd], Y [i/sd] (, . . .) | Plot absolute |
| PD (X [i/sd], Y [i/sd] (, . . .)) | Pen down |
| PR X [i/sd], Y [i/sd] (, . . .) | Plot relative |
| PS paper size [i] | Paper size |
| PT thickness [d] | Pen thickness |
| PU (X [i/sd], Y [i/sd] (, . . .)) | Pen up |
| RA X [i/sd], Y [i/sd] | Shade rectangle absolute |
| RO n [i] | Rotate coordinate system |
| RR X [i/sd], Y [i/sd] | Shade rectangle relative |
| SA | Select alternate character set |
| SC X _{min} [i], X _{max} [i], Y _{min} [i], Y _{max} [i] | Scale |
| SI width [d], height [d] | Absolute character size |
| SL tan φ [d] | Absolute character slant (from vertical) |

Plotter Instruction Set (Continued)

| Instruction | Description |
|---|-------------------------------|
| SM c [c] | Symbol mode |
| SP n [i] | Select pen |
| SR width [d], height [d] | Relative character size |
| SS | Select standard character set |
| TL tp [d] (,tn [d]) | Tick length |
| UC (pen [i],) X [d], Y [d], pen [i] (,...) | User defined character |
| VS v [d] | Select velocity v |
| WG radius [i/sd], start angle [i], sweep angle [i] (,chord angle [i]) | Shade wedge |
| XT | X-axis tick |
| YT | Y-axis tick |

[c] = character format

[i] = integer format, -32 768 to +32 767

[sd] = scaled decimal format, -32 768.0000 to +32 767.9999

How to Use the Examples in This Manual

The examples in this manual are designed primarily to show the use of the instruction with which they appear. If you are new to programming, try entering and running some examples on your computer. You might then wish to change some parameters in an instruction and rerun the plot. The examples are presented in two ways, either as complete programs or as listings of only the pertinent HP-GL strings.

Examples Presented as Complete Programs

Some examples are presented as complete programs, written in a version of Microsoft® GW BASIC for MS™-DOS operating systems. This BASIC is used by several popular personal computers.

Be sure you have established the proper handshaking protocol before running these programs. The 7475A Operation and Interconnection Manual contains configuration examples for several personal computers. If your computer is not listed there, refer to your computer's documentation. It will tell you how to establish communication between your computer and the plotter.

Following is a simple example of the way complete program appears in this manual. You will always need a configuration statement at the

beginning of your program, however, the statement will vary according to the language of your computer.

For plotters with an RS-232-C interface, the configuration statement in line 10 is for Microsoft® GW BASIC.

```
10 OPEN "COM1:9600,N,8,1,RS,CS65535,DS,CD" AS #1
20 PRINT#1, "IN;SP1;PU3000,5400;"
30 PRINT#1, "PD2600,4200,1400,3800,2600,3400;"
40 PRINT#1, "PD3000,2200,3400,3400,4600,3800;"
50 PRINT#1, "PD3400,4200,3000,5400;"
60 PRINT#1, "SP0;"
70 END
```

For plotters with an HP-IB interface, the following configuration statements can be used in line 10 of BASIC programs.

```
10 OPEN, "0", #1, "PLT" (Series 100/BASIC)
```

```
10 OPEN, "LPT3:" FOR OUTPUT AS #1 (GW™-BASIC)
```

The PRINT#1 statement sends the HP-GL instructions, via an output file, to the plotter. Here 1 corresponds to the file number in the OPEN statement.

If you are not using Microsoft® GW BASIC, you will need to insert the proper configuration statement in line 10 *and* may need to change the PRINT#1 statement as well. Refer to your computer's documentation.

When programming in another language, substitute the output or input statement of your language for the BASIC statements PRINT#1 and INPUT#. Change FOR...NEXT loops, etc., to whatever statements are comparable in your language. All characters enclosed in quotes in program listings must be sent to the computer using a form of output statement. In addition, some variables, which are not included in quotes, may need to be sent.

Examples Presented as HP-GL Strings

Since input/output instructions (e.g., PRINT# and INPUT#) do vary so much in different computer languages, many examples present only the pertinent HP-GL strings (the two-letter mnemonics and applicable parameters). They are enclosed in quotation marks since many computers use quotation marks as string delimiters. *The plotter does not require the quotation marks; use whatever your computer requires.*

The Default Instruction, DF

DESCRIPTION The default instruction, DF, sets certain plotter functions to a predefined state.

USES This instruction can be used to return the plotter to a known state while maintaining the same settings of P1 and P2. As a result, unwanted graphics parameters such as character size, slant, or scaling are not inherited from another program.

SYNTAX DF terminator

EXPLANATION No parameters are required; if a parameter is supplied, the instruction will execute and error 2 will be set.

A DF instruction sets the following plotter functions to the conditions shown in the table below.

Default Conditions

| Function | Equivalent Instructions | Conditions |
|------------------------------|-------------------------|---|
| Plotting mode | PA; | Absolute (PA) |
| Relative character direction | DR1,0; | Horizontal (DR1,0) |
| Line type | LT; | Solid line |
| Line pattern length | LT; | 4% of the diagonal distance between P1 to P2 |
| Input window | IW; | Set to current hard-clip limits |
| Relative character size | SR; | Width = 0.75% of $(P2_x - P1_x)$ Height = 1.5% of $(P2_y - P1_y)$ |
| Symbol mode | SM; | Off |
| Tick length | TL; | $t_p = t_n = 0.5\%$ of $(P2_x - P1_x)$ for Y-tick and 0.5% of $(P2_y - P1_y)$ for X-tick |
| Standard character set | CS0; | Set 0 |
| Alternate character set | CA0; | Set 0 |
| Character set selected | SS; | Standard |
| Character slant | SLO; | 0 degrees |
| Mask value | IM 223,0,0 | 223,0,0 |

Default Conditions (Continued)

| Function | Equivalent Instructions | Conditions |
|------------------|-------------------------|---|
| Digitize clear | DC; | Off |
| Scale | SC; | Off |
| Pen velocity | VS; | 38.1 cm/s (15 in./s) |
| Label terminator | DT ETX | ETX (ASCII decimal equivalent 3) |
| Chord angle | — | Set to 5 degrees |
| Fill type | FT; | Set to type 1, bidirectional solid fill |
| Fill spacing | FT; | 1% of the diagonal distance between P1 and P2 |
| Fill angle | FT; | Set to 0 degrees |
| Pen thickness | PT; | Set to 0.3 mm |

The following plotter functions are not affected by a DF instruction:

- Locations of P1 and P2
- Current pen and its position
- 90-degree rotation
- RS-232-C handshaking conventions

The Initialize Instruction, IN

DESCRIPTION The initialize instruction, IN, returns the plotter's graphics conditions to the initial power-on state by program control. This instruction has no effect on handshake protocol or the plotter's state (programmed on or programmed off) in an RS-232-C environment.

USES The instruction can be used to return the plotter to a known state at the beginning of a graphics program so unwanted graphics parameters such as character size, slant, and scaling are not inherited from another program. P1 and P2 are set to power-on positions.

SYNTAX *IN* terminator

EXPLANATION No parameters are required; if a parameter is supplied, the instruction will execute and error 2 will be set.

The initialize instruction sets the plotter to the same conditions as the default instruction, DF, and sets these additional conditions.

- The pen is raised.
- All HP-GL errors are cleared. Bit position 3 of the output status byte is set to true(1) indicating the plotter has been initialized. (This bit is cleared by OS.)
- The rotation state is defaulted to 0 degrees.
- The scaling points P1 and P2 are set as follows:

Default P1 and P2 Scaling Points

| Paper Size | P1 | P2 |
|------------|---------|---------------|
| A | 250,596 | 10 250,7796 |
| A4 | 603,521 | 10 603,7721 |
| B | 522,259 | 15 722,10 259 |
| A3 | 170,602 | 15 370,10 602 |

The Input Mask Instruction, IM

DESCRIPTION The input mask instruction, IM, controls the conditions under which HP-GL error status is reported, the conditions that can cause an HP-IB service request message, and the conditions that can cause a positive response to an HP-IB parallel poll.

USES With both interface configurations (HP-IB and RS-232-C), this instruction can be used to change the conditions under which HP-GL error status is reported. In an HP-IB system only, the instruction is used to enable the plotter to send a service request message when specified bits of the status byte are set, and/or enable a positive response to a parallel poll under the conditions specified.

SYNTAX *IM* E-mask value (,S-mask value (,P-mask value))
terminator
or
IM terminator

EXPLANATION In the RS-232-C configuration, the S- and P-masks are of no use and are ignored if present. The E-mask is used by both configurations.

The E-mask value specified is the sum of any combination of the bit values shown in the following table. When an HP-GL error occurs, the bit in the E-mask corresponding to the error number as shown on the next page is tested to determine if the error bit (bit 5) of the status byte

ditions as the
ns.

status byte
ed. This bit is

| |
|----------|
| P2 |
| 0,7796 |
| 3,7721 |
| 2,10 259 |
| 0,10 602 |

the conditions
tions that can
tions that can

RS-232-C), this
which HP-GL
instruction is
message when
ble a positive

ue))

P-masks are of
by both con-

tion of the bit
ror occurs, the
shown on the
the status byte

is to be set and the front panel **ERROR LED** is to be turned on. If a bit is not set, there is no way to ever determine if that error occurred.

| E-Mask Bit Value | Bit | Error Number | Meaning |
|------------------|-----|--------------|--|
| 1 | 0 | 1 | Instruction not recognized |
| 2 | 1 | 2 | Wrong number of parameters |
| 4 | 2 | 3 | Bad parameter |
| 8 | 3 | 4 | Not used |
| 16 | 4 | 5 | Unknown character set |
| 32 | 5 | 6 | Position overflow |
| 64 | 6 | 7 | Not used |
| 128 | 7 | 8 | Vector or PD received with pinch wheels up |

The default E-mask value of 223 (128 + 64 + 16 + 8 + 4 + 2 + 1) will specify that all errors except error 6 will set the error bit in the status byte and turn on the **ERROR LED** whenever they occur. Error 6 will not set the error bit or turn on the **ERROR LED** if it occurs, since it is not included in the E-mask value. Errors 4 and 7 never occur so setting the E-mask to 151 will set the same conditions as the default value 223.

The S-mask value specified is the sum of any of the bit values shown below. It determines when a service request message will be sent. When a bit of the status byte changes value, the status byte is **ANDed** with the S-mask in a bit-by-bit fashion to determine if bit 6 of the status byte is to be set and the service request message sent. The status of bit 6 changes as plotter conditions change, and is cleared or set as required.

| S-Mask Bit Value | Status Bit Number | Meaning |
|------------------|-------------------|-----------------------------------|
| 1 | 0 | Pen down |
| 2 | 1 | P1 or P2 changed |
| 4 | 2 | Digitized point available |
| 8 | 3 | Initialized |
| 16 | 4 | Ready for data; pinch wheels down |
| 32 | 5 | Error |
| 64 | 6 | Not used |
| 128 | 7 | Not used |

For example, an S-mask value of 4 specifies that when a digitized point is available, setting bit 2, the service request message will be sent. Setting other bits will not send the service request message.

The P-mask value specifies which of the status-byte conditions will result in a logical 1 response to a parallel poll over the HP-IB interface.

| P-Mask Bit Value | Status Bit Number | Meaning |
|------------------|-------------------|-----------------------------------|
| 1 | 0 | Pen down |
| 2 | 1 | P1 or P2 changed |
| 4 | 2 | Digitized point available |
| 8 | 3 | Initialized |
| 16 | 4 | Ready for data; pinch wheels down |
| 32 | 5 | Error |

For example, a P-mask value of 48 specifies that only bits 4 and 5 (16 + 32) of the status byte can cause the plotter to respond to a parallel poll with a logical 1 on the appropriate data line.

The plotter, when set to default values or initialized, automatically sets the E-mask to 223, the S-mask to 0, and the P-mask to 0. An IM instruction without parameters or with invalid parameters also sets the masks to the values 223,0,0.

The Paper Size Instruction, PS

DESCRIPTION The paper size instruction, PS, provides the means to programmatically toggle between A and B, or A3 and A4 paper sizes.

USES This instruction can be used to change the paper sizes programmatically.

SYNTAX PS paper size terminator

EXPLANATION This instruction performs the functions of a front-panel paper size change. The new paper size is determined by the parameter and the setting of the rear-panel paper size switches. A parameter in the range of 0-3 selects either B- or A3-size paper, and a parameter in the range of 4-127 selects either A- or A4-size paper. The PS instruction, however, cannot switch from English to Metric size paper or vice versa. To change from English to Metric size paper, either turn off the plotter and reset the rear-panel paper size switches, or reset the paper size switches and do a front-panel reset (pressing the ENTER and VIEW pushbuttons simultaneously).

If the PS instruction sets the paper size to the current size, the instruction is ignored. If the PS instruction changes the current paper size, a DF instruction is automatically performed. Specifying out-of-range parameters sets error 3 and the instruction is ignored.

Looking Ahead

Of course you want to use your plotter to create high quality graphic plots. Most data display plots fall into one of three broad classes: line graphs, bar graphs, or pie charts. Chapter 8 contains sample programs for a line graph, a bar graph, and a pie chart.

Pie charts are an effective way to show parts of a whole entity; the slices of the pie are the component parts. The pie chart shown here has some segments "exploded" for emphasis. To construct a pie chart, the data is computed as a percentage of the total and each data value is converted to the appropriate segment of a full 360-degree circle. To create a simple pie chart, you can use the WG and EW instructions to draw and fill segments of a circle (arcs) as shown in Chapter 8. Additional information on drawing circles is available under the CI instruction, and on shading and edging the segments of pie charts, under the WG and EW instructions in Chapter 3.

There are three types of bar graphs: simple bar graphs, stacked bar graphs, and clustered bar graphs. The simple bar graph here shows that sales are increasing.

Bar graphs are essentially a collection of rectangles. Each of these rectangles is filled; refer to the FT, RA, and RR instructions in Chapter 3 to learn how to create a filled or hatched rectangle. A stacked bar might be used to show these same sales data broken down into sales by region. Portions of each bar would be colored or shaded differently to show the sales in each region. A sample stacked bar program is shown in Chapter 8. Another way of showing sales by region would be to use a separate bar for each region and to "cluster" all the bars for one year together with a larger space between each cluster of bars.

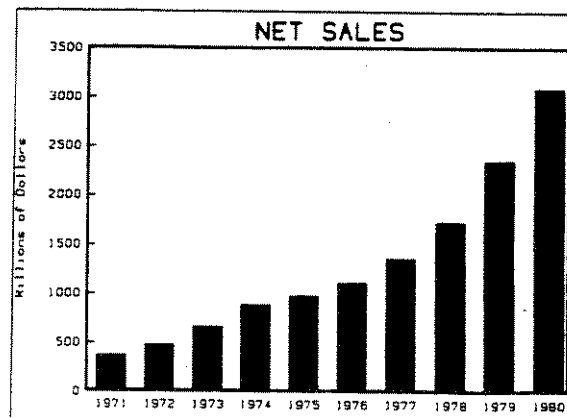
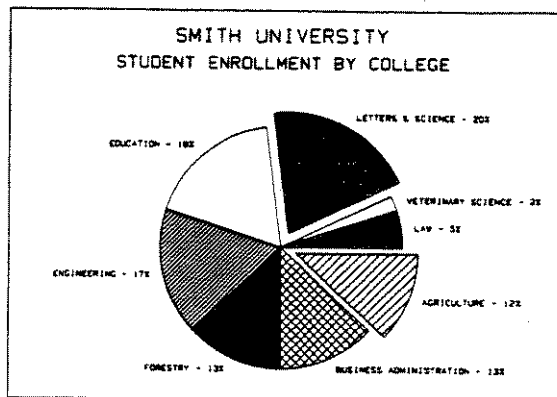

Chapter 2

Establishing Boundaries and Units

What You'll Learn in This Chapter

In this chapter you will learn about the plotting area, how to define a point in this area, and the two kinds of units used to describe the plotting area. After reading this chapter, you will be able to decide which units to use for your data. In addition, you will be able to scale the plotting area into user units appropriate for your data, and to set or read the current scaling points. You will be able to restrict plotting to only a portion of the plotting area, rotate the coordinate system, and read the current limits of the plotting area.

HP-GL Instructions Covered

- IP The Input P1 and P2 Instruction
- OP The Output P1 and P2 Instruction
- SC The Scale Instruction
- IW The Input Window Instruction
- OW The Output Window Instruction
- OH The Output Hard-clip Limits Instruction
- RO The Rotate Coordinate System Instruction

Terms You Should Understand

Scaling — dividing the plotting area into units convenient for your application. Units need not be the same physical size in both axes, nor does there need to be an equal number of units in the X- and Y-axes.

Scaling Points — the points on the plotting surface moved to when the front panel buttons P1 and P2 are pressed. These points are assigned the user-unit values specified by the parameters of the scaling instruction SC.

Window — that part of the plotting area in which plotting of points, lines, and labels can occur. At power on, the window is set to the hard-clip limits of the plotter. Nothing can be drawn outside the current window.

Clipping — restricting plotting to a portion of the plotting area by establishing a window of a certain size.

The Plotting Area

The plotting area is that area of each size paper in which the pen can draw. The default size of the plotting area is determined by the settings of the US/MET and A4/A3 rear-panel switches when power is first turned on. The following table shows the combination switch settings and the maximum plotting range for all four paper sizes.

NOTE: The plotter cannot sense the size of paper that is loaded. It is the user's responsibility to ensure that the paper size switches are set to correspond with the size of paper to be used. ■

Maximum Plotting Ranges

| Paper Size Settings | | Selected Paper Size | Maximum Plotting Range (Plotter Units) | |
|---------------------|-------|----------------------|--|--------------------------------------|
| US/MET | A4/A3 | | X-axis | Y-axis |
| US | A4 | A (8.5 × 11 in.) | 0-10 365 (257.8 mm/ 10.15 in.) | 0-7962 (198.1 mm/ 7.8 in.) |
| US | A3 | B (11 × 17 in.) | 0-16 640 (413.9 mm/ 16.3 in.) | 0-10 365 (257.8 mm/ 10.15 in.) |
| MET | A4 | A4 (210 × 297 mm) | 0-11 040 274.6 mm/ 10.81 in.) | 0-7721 (192.1 mm/ 7.56 in.) |
| MET | A3 | A3 (297 × 420 mm) | 0-16 158 (401.9 mm/ 15.82 in.) | 0-11 040 (274.6 mm/ 10.81 in.) |

Regardless of its size, the plotting area should be thought of as a two-dimensional Cartesian coordinate system. In this system, the entire plotting area is divided (scaled) into a grid as shown in the following illustration. Each intersection of these grid lines represents a distinct point that is expressed by X- and Y-axis coordinates with respect to the origin point (X = 0, Y = 0). For example, the coordinates X = 4, Y = 5 define the point at the intersection of the fourth positive grid line along the X-axis and the fifth positive grid line along the Y-axis. These coordinate values are used as parameters in HP-GL instructions to move the pen to any given point in the plotting area.

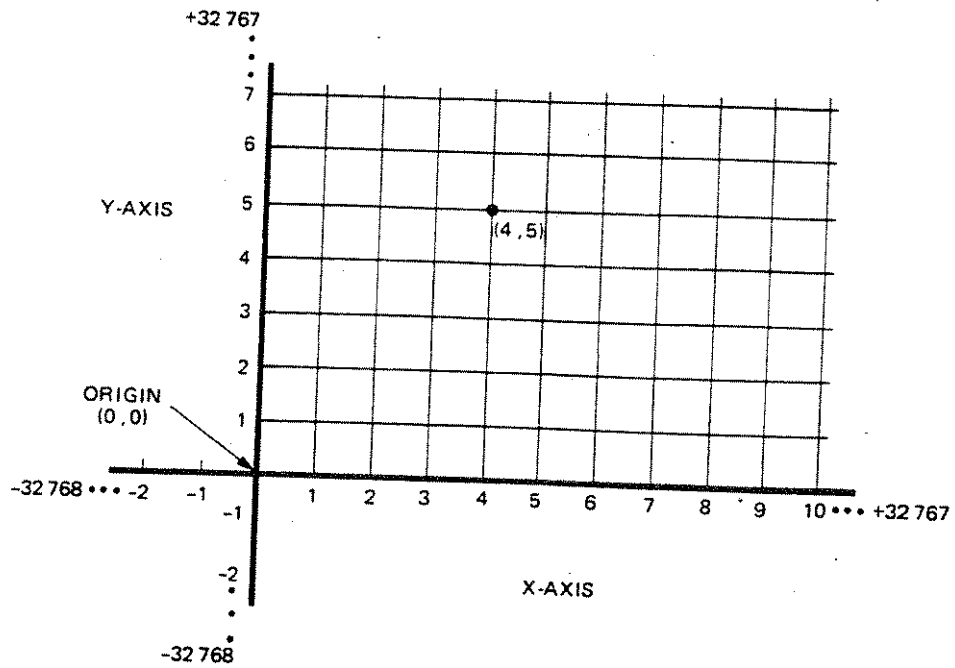

Cartesian Coordinates

The location of the coordinate system origin point and the orientation of the X- and Y-axis with respect to A and A4 or B and A3 paper sizes are shown in the following diagrams. Hard-clip limits and the approximate default locations of scaling points P1 and P2 are also shown. All of these default conditions are determined by the settings of the **US/MET** and **A4/A3** switches when plotter power is first turned on.

The hard-clip limits determine the maximum limits of the pen's motion and the area within which scaling points P1 and P2 can be positioned. Except for narrow margins which are required by the grit wheel paper-moving technology, the hard-clip limits allow plotting on the entire paper surface.

NOTE: The power-up default input window is coincident with the hard-clip limits. The size of the input window can be changed using the instruction **IW** to programmatically limit the pen's motion. ■

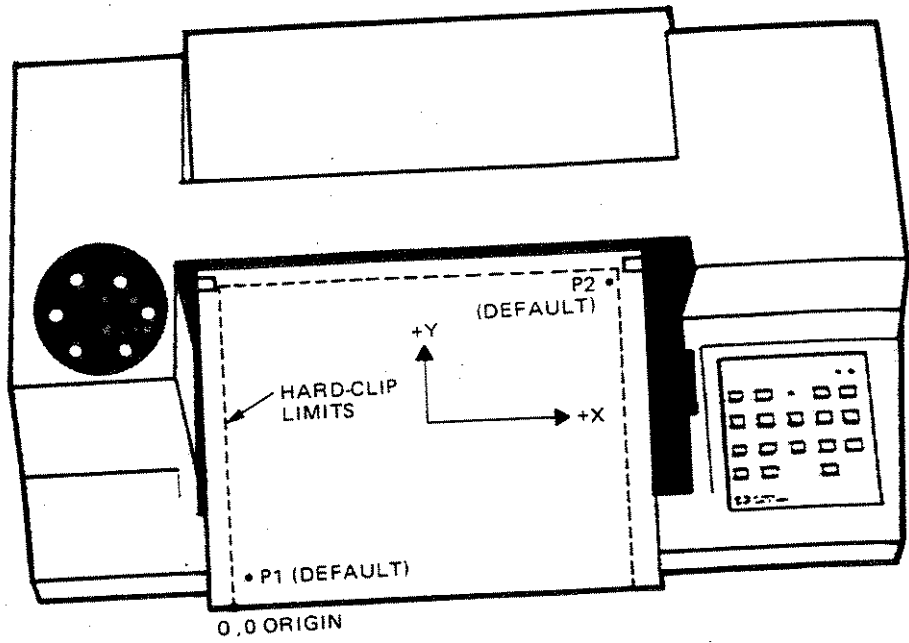

Default Orientation of Plotter Coordinate System (A/A4 Paper)

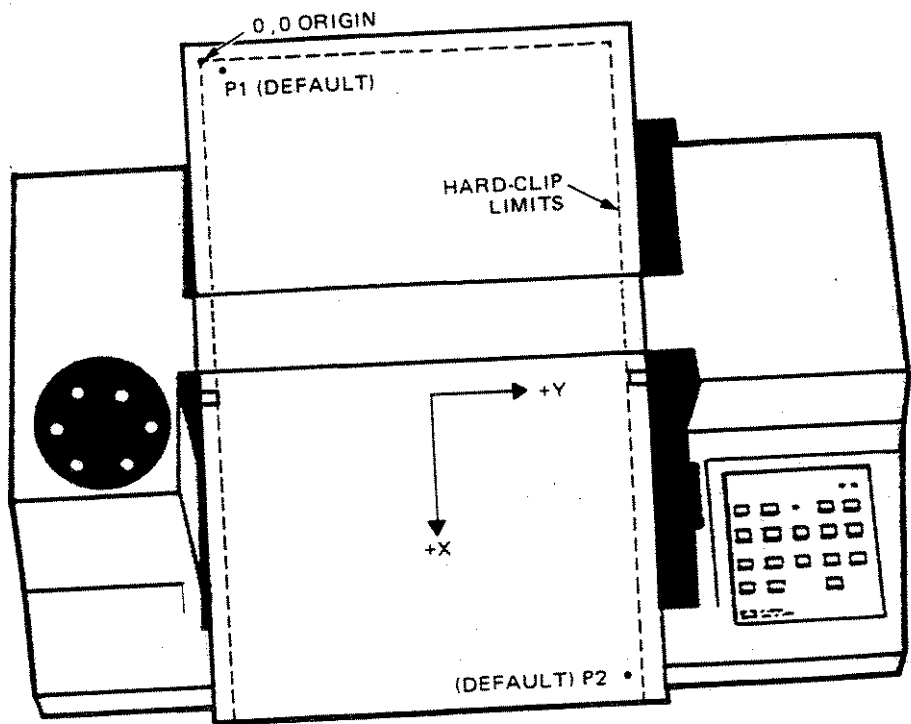

Default Orientation of Plotter Coordinate System (B/A3 Paper)

2-4 ESTABLISHING BOUNDARIES AND UNITS

Unit Systems

There are two unit systems which can be used to define points in the plotting area: plotter units and user units. Plotter units are always the same size. The size of a user unit depends on the parameters of the SC instruction and the settings of the scaling points, P1 and P2.

The Plotter Unit

The plotting area is divided into plotter units; one plotter unit equals 0.02488 mm (0.000 98 in.). There are approximately 40.2 plotter units per millimetre, or approximately 1021 plotter units per inch. One plotter unit is the smallest move the plotter can make. While the pen can only plot within the hard-clip limits, parameters of plot instructions between -32 768 and 32 767 plotter units are understood by the plotter. When plotting in plotter units, only integer values are used; parameters are truncated to integers. Refer to The Plot Absolute Instruction, PA, in Chapter 3.

User Units

The plotting area can also be scaled into user units. This is done with the scale instruction, SC, which assigns values to the scaling points P1 and P2. A user unit may be almost any size. The parameters of the SC instruction are truncated to integers between -32 768 and 32 767. Parameters of plot instructions must also be in that range but may be decimal numbers with fractional parts. Decimal fractions are not truncated; as a matter of fact, the scaling points can be set to 0, 0 and 1, 1 and all of the data can be decimal fractions between 0 and 1. Refer to the plot instructions PA and PR in Chapter 3.

Setting the Scaling Points

On power-up, the default location of scaling point P1 is in the lower-left corner of A/A4 size paper or in the upper-left corner of B/A3 size paper. In each case, the default location of scaling point P2 is in the corner opposite from P1. The exact default coordinate locations of scaling points P1 and P2 are shown in the following table, in plotter units, for the different paper sizes. These default coordinate values define opposite corners of a rectangular area that is centered on the associated size of paper. Regardless of its size, the rectangular area defined by P1 and P2 will hereafter be referred to as the "P1/P2 frame."

Default Coordinate Values for Scaling Points P1 and P2

| Paper Size | Default Scaling Points (Plotter Units) | |
|------------|--|----------------------------------|
| | P1 _x ,P1 _y | P2 _x ,P2 _y |
| A | 250,596 | 10 250,7796 |
| A4 | 603,521 | 10 603,7721 |
| B | 522,259 | 15 722,10 259 |
| A3 | 170,602 | 15 370,10 602 |

The locations of scaling points P1 and P2 can be changed manually from the front panel or programmatically with the instruction IP. Refer to the following paragraph for the manual procedure and to the following section for a description of the instruction IP. The default locations for P1 and P2 can be reestablished by any of the following methods:

- power-up initialization,
- execution of either the instruction IN or the instruction IP without parameters,
- simultaneously pressing **ENTER** and **VIEW** (front-panel reset).

Setting P1 and P2 Manually

P2 moves when P1 is moved manually. If you want P2 to be at a specific location, set P1 first and then P2. If you want to establish an area of a certain size onto which the parameters of a scale instruction will be mapped, you may set P2 in the desired location relative to the current P1, and then move P1. P2 will move to a corresponding location so that both the X- and Y-distances between P1 and P2 remain constant. If such a move means the new location of P2 will be beyond the plotting area, either or both coordinates of P2 will be set to the plotting limits. In this case, the size of the rectangle established by P1 and P2 will, of course, not remain the same. A detailed description, including illustrations, is contained in the HP 7475 Operation and Interconnection Manual.

To set P1 or P2 manually:

1. Move the pen to the desired location using the front-panel cursor (arrow) buttons.
2. Press **ENTER** simultaneously with **P1** or **P2**. If **ENTER** is not held down, the pen will merely move to P1 or P2 and no change in the location of P1 or P2 will occur.
3. Check the new locations of the scaling points by pressing **P1**; then press **P2**.

The Input P1 and P2 Instruction, IP

DESCRIPTION The input P1 and P2 instruction, IP, provides the means to relocate P1 and P2 through program control.

USES The IP instruction is often used to ensure that a plot is always the same size, especially when the user and programmer are not the same person. It establishes program control of plot size and label direction. This instruction can also be used to move the scaling points P1 and P2 from their default or current locations; to give mirror images of vectors and labels; to change the size of a user unit, thus reducing or enlarging an image; to change the size or direction of labels when relative character size or direction is in effect; and to set P1 and P2 back to their default locations.

SYNTAX *IP* P1_x,P1_y (, P2_x,P2_y) terminator
or
IP terminator

EXPLANATION The new coordinates of P1 and P2 are specified in the order shown above and must be in absolute plotter units. Parameters should be ≥ 0 and within the maximum plotting area. Specifying a parameter outside of the maximum plotting range will set error 3 and the instruction will be ignored. Refer to The Plotting Area paragraph, in this chapter, for the maximum plotting ranges on each size of paper.

Specifying the coordinates of P2 is optional. However, if the coordinates of P2 are omitted, then P2 tracks P1 and its coordinates change so that the X- and Y-distances between P1 and P2 do not change.

An IP instruction without parameters sets P1 and P2 to the default coordinate values for the currently selected size of paper. Refer to Setting the Scaling Points, in this chapter, for the default coordinate values of P1 and P2.

Upon receipt of a valid IP instruction, bit position 1 of the output status word is set true (1).

The following HP-GL instruction relocates the scaling points P1 and P2 to the positions shown in the figure.

"IP3000,2000,5000,5000;"

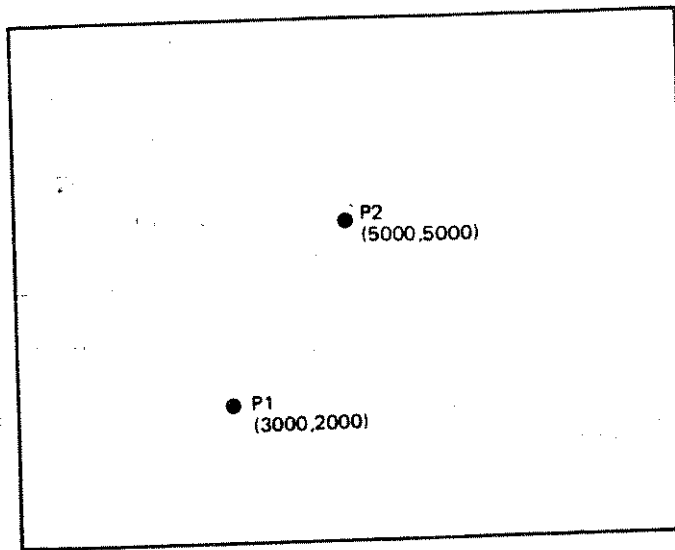

The Output P1 and P2 Instruction, OP

DESCRIPTION The output P1 and P2 instruction, OP, provides the means to make the current coordinates of P1 and P2 available for output.

USES The instruction can be used to determine the position of P1 and P2 in plotter units. This information can be used with the input window instruction, IW, to set the window to P1 and P2 under program control, to compute the number of plotter units per user unit when scaling is on, or to determine the numeric coordinates of P1 and P2 when they have been set manually.

SYNTAX OP terminator

EXPLANATION After an OP instruction is received, the plotter will output the coordinates of P1 and P2 in plotter units as four integers in ASCII in the following form:

P1_x,P1_y,P2_x,P2_y TERM

where TERM is the output terminator for your system. See Terms You Should Understand in Chapter 7.

The range of the integers is limited to the plotting range of the currently selected size of paper as shown on the next page.

Plotting Ranges

| Paper Size | Plotting Range | |
|------------|-------------------------|-------------------------|
| | X-axis | Y-axis |
| A | $0 \leq X \leq 10\ 365$ | $0 \leq Y \leq 7962$ |
| B | $0 \leq X \leq 16\ 640$ | $0 \leq Y \leq 10\ 365$ |
| A4 | $0 \leq X \leq 11\ 040$ | $0 \leq Y \leq 7721$ |
| A3 | $0 \leq X \leq 16\ 158$ | $0 \leq Y \leq 11\ 040$ |

Upon completion of output, bit position 1 of the output status byte is cleared.

The Scale Instruction, SC

DESCRIPTION The scale instruction, SC, establishes a user-unit coordinate system by mapping values onto the scaling points P1 and P2.

USES This instruction is used to enable you to plot in user units convenient to your application. For instance, if your X values represent months, then $X_{min} = 1$ and $X_{max} = 12$. If the values for Y-coordinates all lay between 0 and 10, you might use 0 as Y_{min} and 10 as Y_{max} . By adjusting your minimum and maximum values, you can provide additional room for labeling. If your plot is a 12-month bar chart with Y-coordinates 0 to 10, you might scale the X-axis 0 to 14 so the first and last bars are not at the edge of the graph, and scale the Y-axis 0 to 12 leaving room for a title at the top.

SYNTAX SC $X_{min}, X_{max}, Y_{min}, Y_{max}$ terminator
or
SC terminator

EXPLANATION Executing an SC instruction without parameters (SC;) turns scaling off and subsequent parameters of plot instructions are interpreted as plotter units.

When parameters are used, all four parameters are required. Decimal parameters in an SC instruction are truncated to integers. The parameters X_{min} and Y_{min} define the user-unit coordinates of P1, and the parameters X_{max} and Y_{max} define the user-unit coordinates of P2. P1 and P2 may be any two opposite corners of a rectangle. Scaling points P1 and P2 retain the assigned user-unit coordinate values until scaling is turned off or another SC instruction redefines their user-unit coordinate values. Therefore, the physical size of a user unit will change when any change is made in the relative position and distance between P1 and P2.

Specifying $X_{\max} = X_{\min}$ or $Y_{\max} = Y_{\min}$ will turn off scaling. Specifying parameters less than $-32\,768$ or greater than $32\,767$ sets error 3 and causes the instruction to be ignored. If more than four parameters are specified, the instruction is executed with the first four parameters, error 2 is set, and the rest of the parameters are ignored.

The user-unit coordinate system that is mapped onto the plotter unit coordinate system by the SC instruction is not limited to the rectangle defined by P1 and P2; it extends over the entire plotting area. When user-unit scaling has been established by executing an SC instruction with parameters, decimal parameters of plot instructions are not truncated; the point 3.5, 7.5 is distinct from the point 3.6, 7.8. This is different from some other HP plotters and makes plotting of noninteger data much simpler.

It is not possible to scale an area such that P1 or P2 are assigned values larger than $32\,767$ or less than $-32\,768$. To plot data with values beyond these limits, reduce your data to acceptable ranges by an arithmetic process before sending it to the plotter. This can be accomplished by dividing the data by some factor of 10 so that the integer portions fall between $\pm 32\,767$.

The illustrations which follow show the coordinate grids mapped onto the plotting area as a result of executing the indicated instructions when A size paper is selected. In all cases, the points labeled at each corner are just outside of the plotting area. If a PA instruction with these parameters is sent to a plotter with the indicated scaling and A size paper, the pen will move to the corner and lift, indicating the point is outside the plotting area.

"IP; SC 0,10,0,10;"

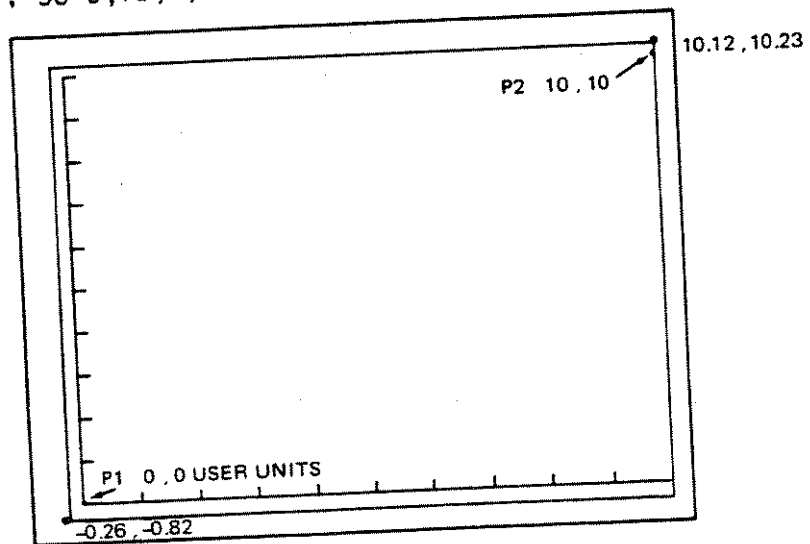

2-10 ESTABLISHING BOUNDARIES AND UNITS

```
"IP 0,0,1000,1000; SC 0,10,0,10;"
```

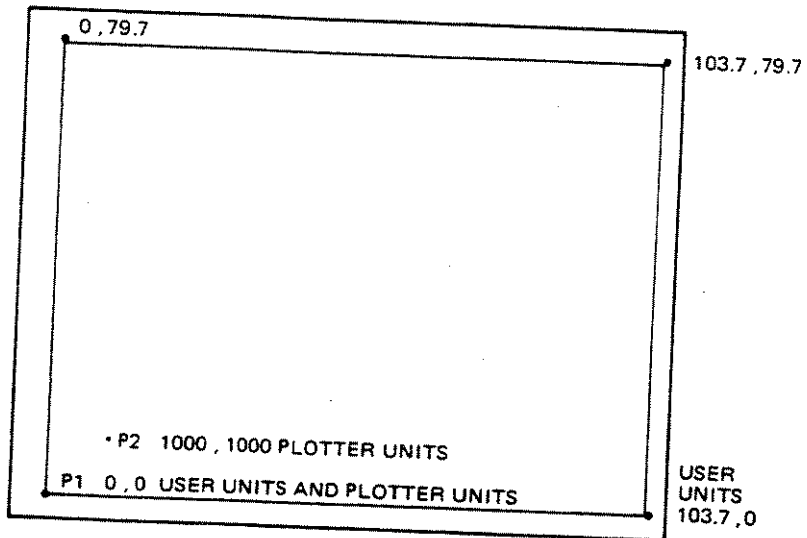

This example scales a square plotting area from 0 to 1 in each axis and draws a unit circle. Change line 10 as necessary for your computer. Line 80 is necessary to limit the number of digits in the X- and Y-coordinates. This prevents the possibility of coordinates being sent to the plotter in scientific notation, which sets an error in the plotter.

```
10 OPEN "COM1:9600,N,8,1,RS,CS65535,DS,CD" AS #1
20 PRINT #1, "IN:IP4000,3000,5000,4000;"
30 PRINT #1, "SP1;SC0,1,0,1;"
40 PI=3.1416
50 FOR T=0 TO 2*PI + PI/20 STEP PI/20
60 X=COS(T)
70 Y=SIN(T)
80 PRINT #1,USING "&+#.####+#.####&";"PA",X,Y,"PD;"
100 NEXT T
110 PRINT #1, "PU;SP0;"
120 END
```

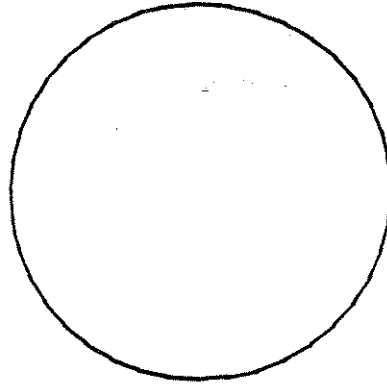

The Input Window Instruction, IW

DESCRIPTION The input window instruction, IW, provides the means to restrict programmed pen motion to a rectangular area of the plotting surface. This area is called the "window."

USES The instruction can be used to restrict plotting to a certain area of the paper. The instruction is especially useful when your data should fall in a certain range but your scaling is larger (perhaps you have left room for labels) and you don't want lines outside the normal data area.

SYNTAX *IW* $X_{\text{lower left}}, Y_{\text{lower left}}, X_{\text{upper right}}, Y_{\text{upper right}}$ terminator
or
IW terminator

EXPLANATION Parameters are always interpreted as plotter units. When four parameters are included, the window is set according to the parameters. If no parameters are included, the window is set to the maximum plotting area of the currently selected size of paper.

The four parameters specify, in absolute plotter units, the X- and Y-coordinates of the lower-left and upper-right corners of the window area. The parameters should be positive and less than 10 365, 16 640, 11 040, or 16 158 for X (depending on the currently selected paper size) and less than 7962, 10 365, 7721, and 11 040 for Y. Parameters between -32 768 and 0 are set to 0. Parameters larger than the limits of the absolute plotting area but less than 32 767 are set to the above-mentioned limits for X and Y. If X- or Y-parameters of the lower-left corner are specified to be greater than the X- or Y-parameters of the upper-right corner, the parameters will be automatically interchanged. For example, IW6000, 3000, 5000, 4000 will be converted to IW5000, 3000, 6000, 4000.

At power on, after a front-panel reset, or when an IN or DF instruction is executed, the window is automatically set to the current hard-clip limits, i.e., maximum plotting area.

The Output Window Instruction, OW

DESCRIPTION The output window instruction, OW, provides the means to obtain the X- and Y-coordinates of the lower-left and upper-right corners of the window area in which plotting can currently occur.

USES The instruction can be used to determine the area in which any plotting will occur.

SYNTAX OW terminator

EXPLANATION No parameters are used. Output is in plotter units.

After an OW instruction is received, the plotter will output the coordinates of opposite corners of the plotting area in plotter units as four integers in ASCII in the following form:

$X_{\text{lower left}}$, $Y_{\text{lower left}}$, $X_{\text{upper right}}$, $Y_{\text{upper right}}$ TERM

where TERM is the output terminator for your system. See Terms You Should Understand in Chapter 7.

The range of the integers is limited to the plotting range of the currently selected size of paper as follows:

Plotting Ranges

| Paper Size | Plotting Range | |
|------------|-------------------------|-------------------------|
| | X-axis | Y-axis |
| A | $0 \leq X \leq 10\ 365$ | $0 \leq Y \leq 7962$ |
| B | $0 \leq X \leq 16\ 640$ | $0 \leq Y \leq 10\ 365$ |
| A4 | $0 \leq X \leq 11\ 040$ | $0 \leq Y \leq 7721$ |
| A3 | $0 \leq X \leq 16\ 158$ | $0 \leq Y \leq 11\ 040$ |

The Output Hard-clip Limits Instruction, OH

DESCRIPTION The output hard-clip limits instruction, OH, is used to output the lower-left (LL) and upper-right (UR) coordinates of the current hard-clip limits.

USES This instruction can be used with the IP instruction to determine and make use of the maximum available plotting area.

SYNTAX OH terminator

EXPLANATION After an OH instruction is received, the plotter will output the LL and UR coordinates in plotter units as four ASCII integers in the following form:

X_{lower left}, Y_{lower left}, X_{upper right}, Y_{upper right}, TERM

where TERM is the output terminator for your system. See Terms You Should Understand in Chapter 7.

The plotter suppresses leading zeros and positive signs. The Input P1 and P2 Instruction, IP, can be used to relocate P1 and P2 to the maximum plotting area as determined by the OH instruction. Refer to Chapter 2 for additional information on the IP instruction. Use of an IW instruction (soft clipping) does not affect the output from the OH instruction. Changing the paper size, however, will change the hard-clip limits. The 90-degree rotation function will change the UR coordinate values. Thus, if the absolute Y-axis value is larger than the absolute X-axis value, you know that the coordinate axes are rotated from their default orientation.

The Rotate Coordinate System Instruction, RO

DESCRIPTION The rotate coordinate system instruction, RO, programmatically rotates the plotter unit/user-unit coordinate systems 90 degrees.

USES This instruction is used to orient plots vertically or horizontally, regardless of whether the paper is loaded with the short or long dimension along the pen-axis.

SYNTAX RO (angle in degrees) terminator
or
RO terminator

EXPLANATION The only allowable parameters are 0 and 90. The instruction RO90; rotates the current coordinate system 90 degrees from its default orientation as shown in the following diagrams for A/A4 and B/A3 paper sizes. Rotations are not cumulative, and the rotate function can only be toggled on and off. The instruction RO0; is the same as RO; and turns off the rotate function.

When an RO90; instruction is executed, P1 and P2 retain their current coordinate values and may therefore be rotated outside the hard-clip limits. The current input window is also rotated, and any portion that is rotated outside of the hard-clip limits is clipped to the hard-clip

limits. The size of the clipped input window can be determined by executing the OW instruction. The input window can be expanded to the hard-clip limits and P1 and P2 can be defaulted to their rotated default coordinate values using the instructions IW and IP without parameters.

Rotated Default Coordinate Values for Scaling Points P1 and P2

| Paper Size | Rotated Default Scaling Points (Plotter Units) | |
|------------|--|----------------------------------|
| | P1 _x ,P1 _y | P2 _x ,P2 _y |
| A | 154,244 | 7354,10 244 |
| A4 | 0,610 | 7200,10 610 |
| B | 283,934 | 10 283,16 134 |
| A3 | 607,797 | 10 607,15 997 |

The 0,0 origin point moves when the coordinate system is rotated, but the physical size and location of the hard-clip limits are not affected. However, the defined lower-left (LL) and upper-right (UR) corners of the hard-clip limits are rotated to maintain the same relationship with respect to the 0,0 origin point. The coordinate values for UR are determined by paper size and the state of the rotate function; but the coordinate values for LL will always be 0,0 regardless of paper size and the state of the rotate function. The current plotter unit coordinate values for LL and UR can be obtained by executing the OH instruction.

When the coordinate system is rotated, the logical pen position is changed to correspond with the current physical pen position. The coordinate values of the new logical pen position can be obtained by executing either an OA or OC instruction after the rotate instruction is executed.

Specifying parameters other than 0 or 90 sets error 3 and the instruction is ignored. If you specify too many parameters, the instruction is executed with the first parameter, error 2 is set, and the rest of the parameters are ignored.

You can also turn rotation on and off via the front panel. Press the **ENTER** and **FAST** buttons simultaneously to turn on rotation; press again to turn it off. Unlike the RO instruction, the front-panel rotation automatically defaults the input window and the P1/P2 frame. You can also determine the state of the rotate function using the OH and OS instructions. Refer to the OH instruction in this chapter and the OS instruction in Chapter 7 for details.

The initialize instruction, IN, defaults the rotation state to 0 degrees.

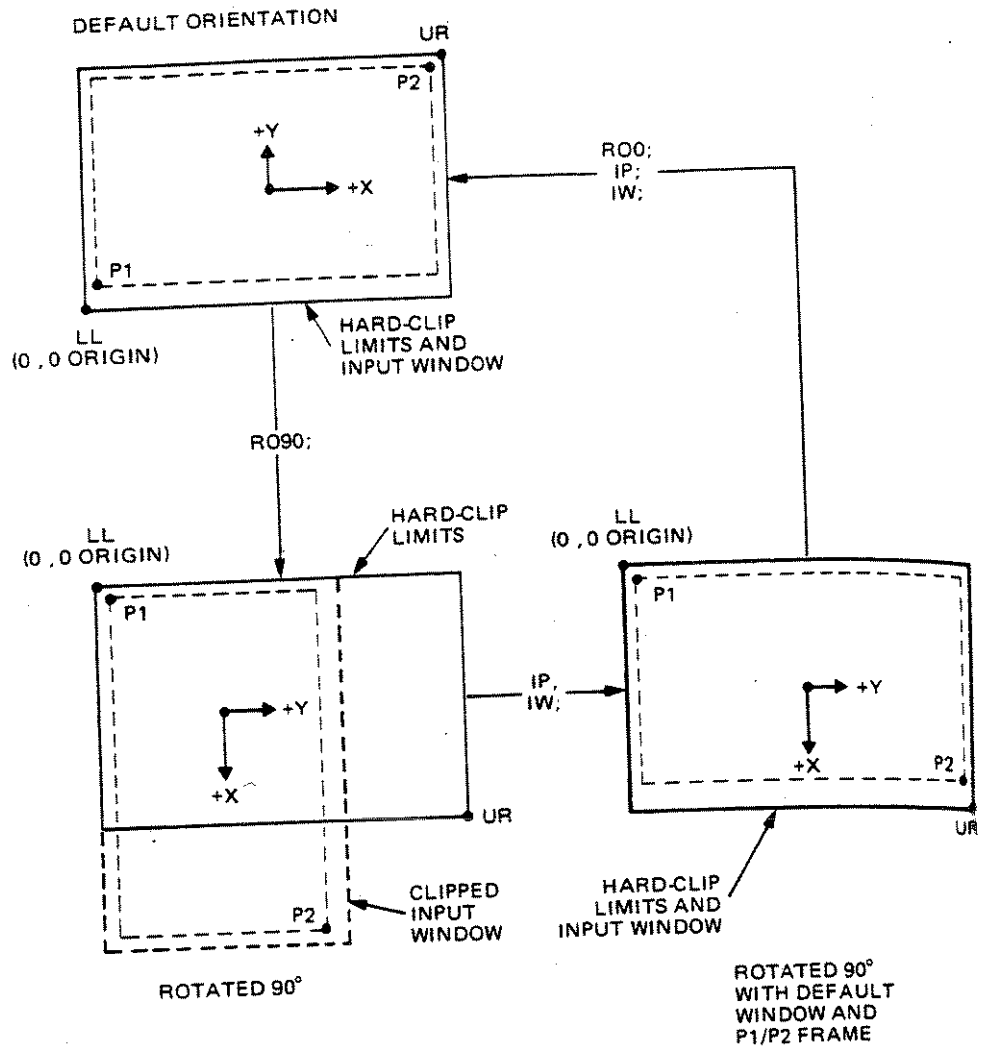

Rotation on A/A4 Size Paper

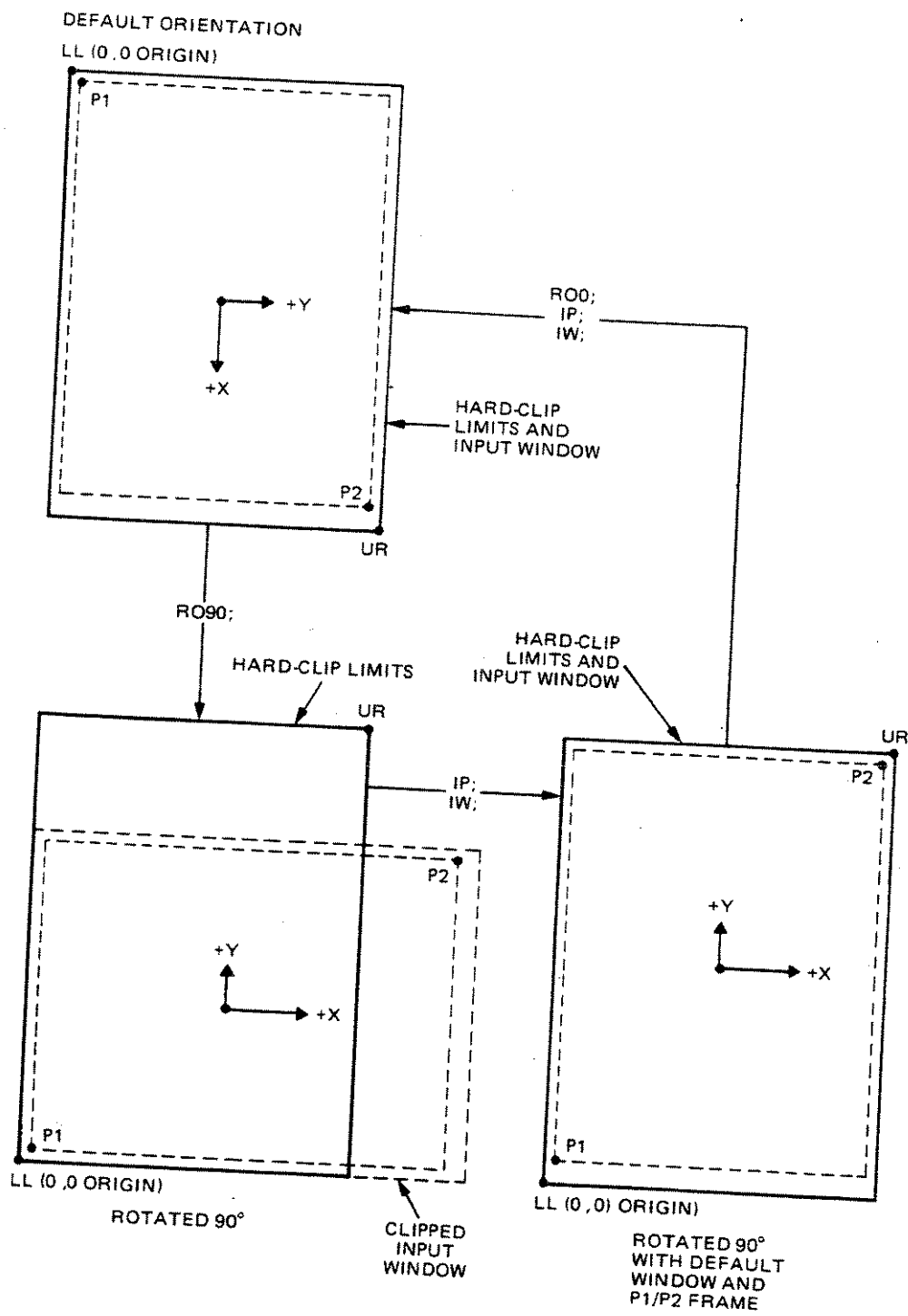

Rotation on B/A3 Size Paper

Chapter 3

Controlling the Pen and Plotting

What You'll Learn in This Chapter

Now that you understand the unit systems in which data can be represented, you are ready to create plots. In this chapter, you will learn how to select or change pens, how to set and change pen velocity, how to raise and lower the pen, and how to plot. You will learn how to plot to absolute X,Y coordinates or to plot relative to the last pen position. You will also learn how to send variables as parameters of plot instructions; this will enable you to write general purpose graphics programs. Finally, you will learn how to define and fill rectangles and arc segments.

HP-GL Instructions Covered

| | |
|-------|--|
| SP | The Select Pen Instruction |
| VS | The Velocity Select Instruction |
| PU/PD | The Pen Up/Down Instructions |
| PA | The Plot Absolute Instruction |
| PR | The Plot Relative Instruction |
| CI | The Circle Instruction |
| AA | The Arc Absolute Instruction |
| AR | The Arc Relative Instruction |
| FT | The Fill Type Instruction |
| PT | The Pen Thickness Instruction |
| RA | The Shade Rectangle Absolute Instruction |
| EA | The Edge Rectangle Absolute Instruction |
| RR | The Shade Rectangle Relative Instruction |
| ER | The Edge Rectangle Relative Instruction |
| WG | The Shade Wedge Instruction |
| EW | The Edge Wedge Instruction |

Terms You Should Understand

Absolute Plotting — plotting to a point whose location is specified relative to the origin (0, 0). When the PA instruction is used to plot to a point, the pen always moves to the same point on the plotting surface, no matter where the pen was before the move.

Relative Plotting — plotting to a point whose location is specified relative to the current pen position. The point moved to then becomes

the effective origin for the next parameter of a plot relative instruction. When the PR instruction is used to plot to a point, the destination of the pen depends on where the pen was when the instruction was received.

Plotter Unit Equivalent — the X,Y coordinates of a point, given in user units, if they were expressed in plotter units.

The Pen Instructions, PU and PD

DESCRIPTION The pen up instruction, PU, and the pen down instruction, PD, raise and lower the pen.

USES The instructions are used to raise and lower the pen during plotting. They may be used with parameters to plot or move to the points specified by the parameters.

SYNTAX *PU* terminator
or
PD terminator
and
PU X,Y(. . .) terminator
or
PD X,Y(. . .) terminator

EXPLANATION When no parameters are included, the pen up instruction, PU, raises the pen without moving it to a new location. The pen down instruction, PD, lowers the pen without moving it to a new location, if the pen is within the window. If parameters are included, the pen will move, in order, to the X,Y coordinates specified. The coordinates are interpreted as plotter units if scaling is off and user units if scaling is on. Moves are either relative or absolute, depending on whether a PA or PR was the last plot instruction executed.

If parameters are included, both coordinates of an X,Y coordinate pair must be given. An odd number of parameters will set an error condition, but all X,Y pairs which precede the unmatched parameter will be plotted. For a description of the PU and PD instructions with parameters, refer to The Plot Absolute Instruction, PA, and The Plot Relative Instruction, PR, which follow.

NOTE: The plotter has an automatic pen lift feature which will lift the pen after it has been in the pen-down state for 55 seconds and no pen-down plot instructions or label instructions have been sent to the plotter or no front-panel pen-down moves have been made for 55 seconds. ■

The Select Pen Instruction, SP

DESCRIPTION The select pen instruction, SP, selects and/or stores a pen.

USES The instruction is used to load a pen into the pen holder so that drawing will occur. It can be used to select a pen of a different color or width, during the plotting program. It can be used with a zero parameter or no parameter to store the pen currently in the pen holder into its stall at the end of a program.

SYNTAX SP pen number terminator
or
SP terminator

EXPLANATION The pen parameter must be in the range of $0 \leq n \leq 6$. Decimal fractions are truncated. A zero parameter or no parameter stores the pen unless the pen carousel is full. If the pen carousel is full, the plotter will try to put the pen away in the appropriate stall. If the stall is occupied, the plotter will attempt to store the pen in pen stalls 1 through 6 in order. If all the stalls are full, the pen holder will return to its previous location. When a pen parameter is out of range, the parameter is ignored and the pen does not change. If the pen designated for selection is not in its stall, the plotter will attempt to select a pen beginning in stall 1 and continuing through stall 6 until a pen is found.

The Velocity Select Instruction, VS

DESCRIPTION The velocity select instruction, VS, specifies the pen-down speed for plotting and labeling operations.

USES The instruction is used to set velocity to a speed other than the default velocity of 38.1 cm/s and to change the acceleration from its default value of 2 g (980 cm/s²). This instruction should be used to slow velocity to 10 cm/s when plotting on transparency film. A slightly thicker line can be created by slowing down the pen speed on any medium. A pen nearing the end of its life will write with a clearer, sharper, more solid line if the velocity is slowed.

SYNTAX VS pen velocity terminator
or
VS terminator

EXPLANATION A VS instruction without parameters sets pen velocity to its default velocity of 38.1 cm/s (15 in./s) and acceleration to 2 g (980 cm/s²). A VS instruction with parameters sets the pen velocity for horizontal or vertical pen-down moves to the value specified by the first parameter and slows the acceleration to 0.5 g. Anything after the first parameter is ignored. Parameters must be in the range 0 to

127.9999. A velocity of 0 is set to 0.38 cm/s. Velocity can be set in increments of 0.38 cm/s. Parameters are rounded to the nearest multiple of 0.38 cm/s. Negative parameters and parameters greater than or equal to 128 set an error condition (error 3) and the velocity does not change. Parameters between 38.1 and 127.9999 set velocity to its default value of 38.1 cm/s.

When either the horizontal or vertical velocity falls in the range 0.38 to 3.8 cm/s, it is reset to a slower or faster velocity to avoid this range. This is done to assure lines of high quality. The change is most noticeable when a line is almost vertical or almost horizontal. Pen-down moves will be at the specified velocity except when such adjustment is necessary.

Execution of a VS instruction with a parameter of 38.1 will slow the acceleration, giving the highest line quality at that maximum speed.

A default instruction, DF, or an initialize instruction, IN, will also reset the velocity and acceleration to the values 38.1 cm/s and 2 g.

The Plot Absolute Instruction, PA

DESCRIPTION The plot absolute instruction, PA, moves the pen to the point(s) specified by the X- and Y-coordinate parameters.

USES The instruction can be used together with PD to draw lines or with PU to move the pen to a specific point on the plot. The instruction can be executed without parameters to establish absolute plotting, as opposed to relative plotting for PU or PD instructions with parameters. In this case, the parameters of PU and PD are interpreted as absolute X,Y coordinates until any PR instruction is received.

SYNTAX PA X₁ coordinate, Y₁ coordinate (, X₂ coordinate,
Y₂ coordinate, . . . , X_n coordinate, Y_n coordinate)
terminator
or
PA terminator

EXPLANATION Recommended parameters are decimal numbers between -32 768.0000 and 32 767.9999. When scaling is off, parameters are truncated to integers as follows:

- For positive numbers, the fractional portion is ignored and the integer portion remains unchanged. For example, both 1234.4 and 1234.9 become 1234.
- For negative numbers, the fractional portion is ignored and the integer portion is changed to the next negative integer. For example, both -1234.4 and -1234.9 become -1235. Since you cannot plot to negative values unless scaling is on, (in which case decimal portions

If no pen control parameter is given, the pen will assume the pen state (up or down) of the previous statement. The PU or PD mnemonics can also be substituted for the PA (or PR) mnemonic. This is equivalent to having PU; or PD; preceding the PA or PR instruction. Therefore, PU and PD with parameters are interpreted to be in place of PA or PR, depending upon which mnemonic, PA or PR, was last specified.

PA is specified by any of the following:

- power-up or front-panel reset,
- execution of an IN instruction,
- execution of a DF instruction, or
- execution of a PA instruction with or without parameters.

The pen moves and draws lines only within the currently defined window. Refer to The Input Window Instruction, IW, in Chapter 1.

The plotter ignores parameters which are out of range, does not change the pen state, and sets error 3 (parameter out of range). When scaling is off, in-range parameters are greater than or equal to -32 768 and less than or equal to 32 767. When scaling is on, both the parameters and their plotter unit equivalent must also be in that same range. To find the plotter unit equivalent, use the equations in the section Scaling Without Using the SC Instruction in Appendix C.

There are four types of vectors that can be drawn with a PA instruction from a given last point to some new point.

| LAST POINT | | NEW POINT | |
|------------|---------------------|-----------|---------------------|
| 1. | inside window area | to | inside window area |
| 2. | inside window area | to | outside window area |
| 3. | outside window area | to | inside window area |
| 4. | outside window area | to | outside window area |

In type one, the pen moves from the last point to the new point with the pen up or down as programmed.

In type two, the pen moves from the last point toward the new point and stops where the line between the two points intersects the current window. The pen up/down condition is as programmed until the intersection is reached. Then, the pen is raised.

In type three, the pen moves with the pen up, to the point where the straight line between the last and new point intersects the window limit. When the pen reaches this point, the pen assumes its programmed (up or down) position. The pen then moves to the new point.

In type four, no pen movement occurs unless the straight line between the last and new point intersects the window. The X- and Y-coordinates

of the current pen position are updated. If part of the vector is in the window area, the pen moves, pen up, to the point where the line between the last and the new point first intersects the window limit. The pen moves under programmed pen up/down control to the intersection of the vector and the other window limit. At this point, the pen stops and lifts.

Since out-of-range points are ignored, the plotter will draw a line between the two points on either side of discarded points. You can be sure all lines on your plot represent actual data if you:

1. have not changed the error mask from its default setting;
2. have not executed an output error instruction; and
3. the error light is not on at the end of your plot.

(The fact that the error light is on does not necessarily mean out-of-range data has been encountered; for example, an error in any HP-GL instruction will turn the light on.)

The following strings of HP-GL instructions, if sent to the plotter using a suitable output statement such as PRINT#, will draw two triangles and then move to the point 10 365 , 7721 with the pen up.

```
"IN;SP1;PA2000,1500;"  
"PD500,1500,2000,3500,2000,1500;"  
"PU2500,1500;"  
"PD4000,1500,2500,3500,2500,1500;"  
"PU10365,7721;"
```

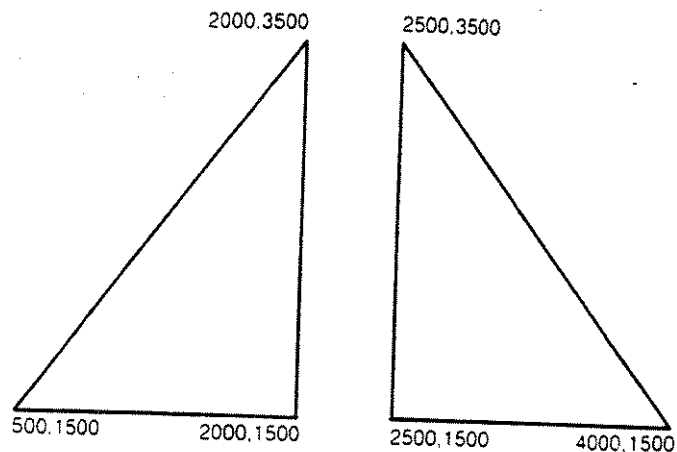

The next strings of HP-GL instructions scale the plotting area into user units 0 to 100 in each axis and again draws two triangles. Use an output statement implemented on your computer to send the strings to the plotter.

```
#1, "IN;SP1;SC0,100,0,100;"
#1, "PA20,15;PDS,15,20,35,20,15;"
#1, "PU25,15;PD40,15,25,35,25,15;PU;"
```

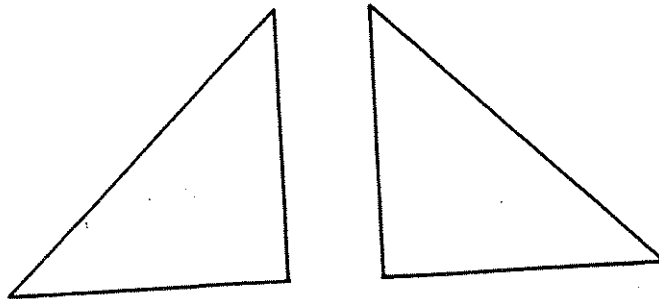

The Plot Relative Instruction, PR

DESCRIPTION The plot relative instruction, PR, moves the pen relative to its current location by the number of units specified by the X- and Y-increment parameters.

USES The plot relative instruction can be used like a PA instruction to draw lines and move to a point. However, with PR, pen movement is relative to the current pen position. The instruction can be executed without parameters to establish relative plotting as opposed to absolute plotting for PU or PD instructions with parameters. It is often used to draw multiple occurrences of some figure on a plot, for example, to draw several rectangles of the same size.

SYNTAX PR X₁ increment, Y₁ increment, (X₂ increment,
Y₂ increment, . . . , X_n increment, Y_n increment)
terminator
or
PR terminator

EXPLANATION Recommended parameters are in decimal numbers between -32 768.0000 and 32 767.9999. Their plotter unit equivalents should also be in the same range. When scaling is off, parameters are truncated to integers in the manner described under the plot absolute instruction. When scaling is on, any fractional portion of a parameter is used.

A PR instruction requires that both increments of an X,Y pair be given. An odd number of parameters will set an error condition but all X,Y pairs which precede the unmatched parameter will be plotted.

The X-increment specifies, in either plotter units or user units, the number of units the pen will move in the direction of the X-axis. The Y-increment specifies, in either plotter units or user units, the number

of units the pen will move in the direction of the Y-axis. The sign of the parameter determines the direction of movement; a positive value moves the pen in the positive direction and a negative value moves the pen in the negative direction. If scaling is on, both parameters are interpreted as user units. If scaling is off, both parameters are interpreted as plotter units.

The mnemonics PU and PD can be included ahead of, between, or after X,Y increment pairs. PU lifts the pen; PD lowers the pen. Any number of increment pairs, as well as PU or PD mnemonics, (limited only by the ability of the controller to output without a line feed character) can be listed after the PR instruction. The placement of optional or required separators and the terminator is the same as for the PA instruction.

If no pen control parameter is given, the pen will assume the pen state (up or down) of the previous statement. The PU or PD mnemonics can also be substituted for the PR (or PA) mnemonic. This is equivalent to having PU; or PD; preceding the PR or PA instruction. Since the power-on default is absolute plotting mode, a PR instruction must be executed before parameters of PD or PU instructions will be interpreted as X,Y increments. Relative plotting mode is cancelled by execution of a PA, IN, or DF instruction.

The pen moves and draws lines only within the currently defined window. Refer to The Input Window Instruction, IW, Chapter 1. Drawing of vectors in relation to the window is as described under the PA instruction.

The plotter ignores parameters which are out of range or whose plotter unit equivalent would be out of range if the indicated move were made. Error 3 is set (out-of-range parameter).

When scaling is off, in-range parameters are between -32 768 and 32 767. When scaling is on, in-range parameters and their plotter unit equivalent must be between -32 768.0000 and 32 767.9999. To find plotter unit equivalents, refer to the section Converting from User Units to Plotter Units in Appendix C.

The following strings of HP-GL instructions, when sent to the plotter using your computer's output statements, cause triangles to be drawn that are identical to the ones previously drawn using only the PA instruction. The numbers in parentheses on the plot are the X,Y increments of the PR instructions. The numbers without parentheses are the plotter unit coordinates of the vertices.

```

"IN:SPI;PA2000,1500;"
"PR;PD-1500,0,1500,2000,0,-2000;"
"PU500,0;"
"PD1500,0,-1500,2000,0,-2000;PU;"

```

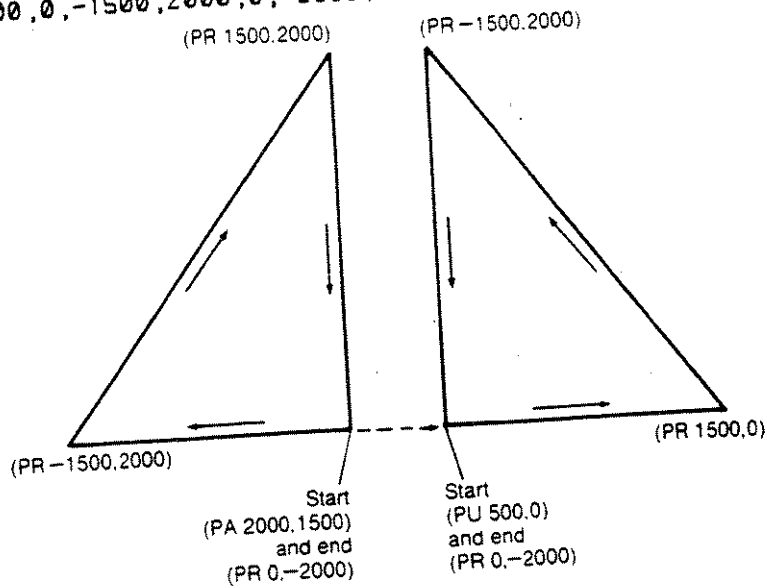

Plotting with Variables

For some plotting applications, you may want to substitute variables for numeric parameters in an HP-GL instruction. This is simple to do. Just remember these principles:

- The values of all parameters have the same restrictions (integer or decimal in a valid range) when sent as variables as they do when sent as constants.
- HP-GL mnemonics, their separators, and their terminators all must be sent to the plotter along with the variable parameters.

NOTE: The methods used to send HP-GL instructions to the plotter vary from computer to computer. Those discussed here are specific to the HP Series 80 computer. However, the principles apply to any computer. ■

How to Send Variable Parameters

The usual way to send an HP-GL instruction with *numeric* parameters is to send the mnemonic, parameters, separators, and terminator as a literal string. However, the plotter will record an error if you send *variable* parameters within a literal string.

The best way to send variable parameters is to send only the mnemonic and terminator as literal strings, and send the parameters between

them. The following instructions demonstrate this method and show the characters as they are received by the plotter. (Assume that the program defines the variables as $X = 80$ and $Y = 90$.)

1. Instructions sent: `PRINT "PA",10,20,X,Y,";"`

Plotter receives:

PA 10 20 80 90 ;

2. Instructions sent: `PRINT "PA";10;20;X;Y;" ;"`

Plotter receives: PA 10 20 80 90 ;

Instructions 1 and 2 are similar except for the use of commas versus semicolons between the parameters. Using a comma often means that unnecessary blank spaces are sent. A semicolon separator sends only leading and trailing blanks between the parameters. The semicolon uses the interface bus most efficiently. Refer to the program in Chapter 8 to see how variables are sent.

The Circle Instruction, CI

DESCRIPTION The circle instruction, CI, provides the means to draw a circle of a specified radius and chord angle.

USES The instruction can be used to generate circles with a single instruction. All computations are internal to the plotter to reduce computer overhead.

SYNTAX `CI radius (, chord angle) terminator`

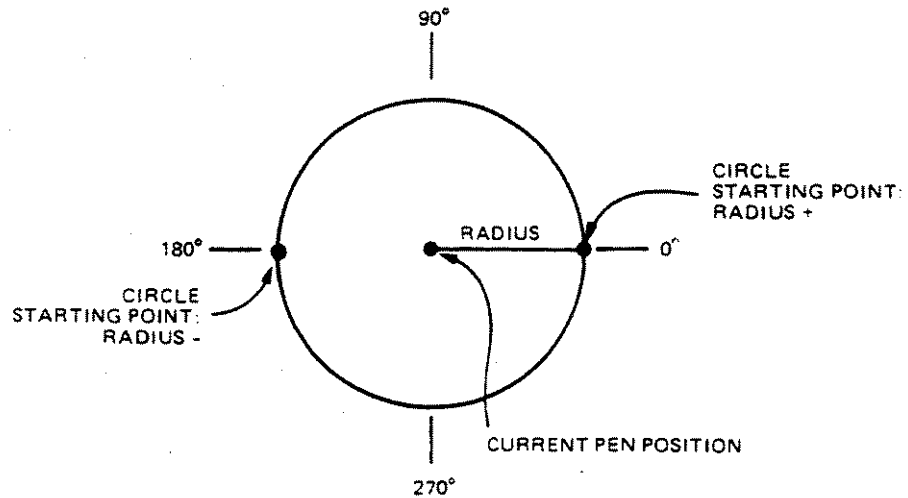

EXPLANATION The radius parameter can be a positive or negative number in integer or scaled decimal format. Its sign defines the starting point of the circle: a circle with a positive radius starts at the 0-degree

point; a circle with a negative radius starts at the 180-degree point. The current pen position is the center of the circle. If scaling is off, the radius is in plotter units. If scaling is on, the radius is in user units. If user units are not the same size in the X- and Y-directions, ellipses will be drawn.

The chord angle parameter is in integer format and governs the smoothness of the circle. It is interpreted as degrees and sets the maximum angle subtended by a chord that is drawn to represent an arc segment of the circle, as shown below. The actual angle used may be changed by the plotter so that all chords are the same length. The sign of the parameter is ignored, except to set the maximum in-range limit to -32768 or +32767.

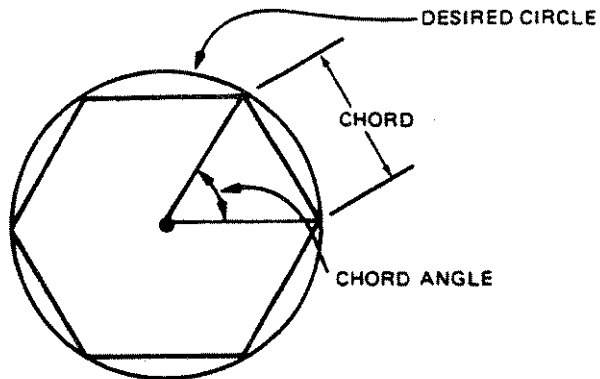

The most useful chord angle values range from 0 to 180; where 0 produces the smoothest circle and larger numbers progressively reduce the number of chords used. Values from 180 to 360 work just the opposite; i.e., larger numbers progressively increase the number of chords used and 360 produces the smoothest circle. This pattern follows modulo 360 through the permitted range of -32768 to +32767. Specifying out-of-range parameters sets error 3 and the instruction is ignored.

The following strings of HP-GL instructions, when sent to the plotter using your computer's output statements, show the effect of different chord angles.

```
"IN;SP1;IP3650,2325,6650,5325;"
"SC-100,100,-100,100;"
"PA-50,40;CI30,45;"
"PA50,40;CI30,30;"
"PA-50,-40;CI30,15;"
"PA50,-40;CI30,5;"
"SP0;"
```

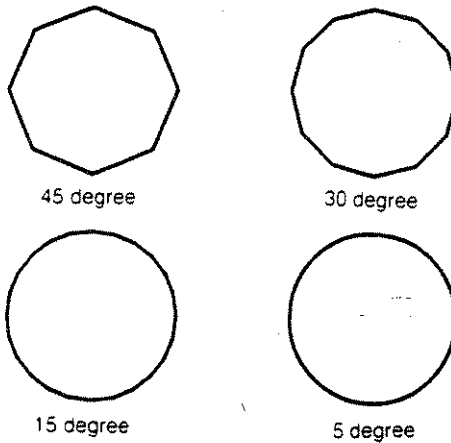

The circle instruction includes an automatic pen down feature. When a circle instruction is received, the pen lifts (if it was down), moves from the center of the circle to the circle starting point on the circumference, lowers the pen, draws the circle, then returns, pen up, to the center of the circle. After drawing the circle, the pen assumes the pen state (up or down) that was in effect prior to the circle instruction. To avoid drawing lines to the center of the circle, move to and away from the circle's center with the pen up.

Circles are drawn within the defined window, with clipping occurring outside the window limits. Drawing circles within the window conforms to the definitions given for plotting under the PA instruction.

Each chord of the circle is drawn using the currently defined line type. Refer to The Line Type Instruction, LT, in Chapter 4.

To demonstrate some of the features of the circle instruction, the following strings of HP-GL instructions draw various circles with different line types, radii, and starting points.

```
"IN;SP1;IP2650,1325,7650,6325;"
"SC-100,100,-100,100;"
"PA0,0;LT;CI10,S;LT0;CI-20,S;LT1;CI30,S;"
"LT2;CI-40,S;LT3;CI50,S;LT4;CI-60,S;LTS;"
"CI70,S;LT6;CI80,S;"
"SP0;"
```

SYNTAX AA X-coordinate, Y-coordinate, arc angle (, chord angle)
 AA terminator

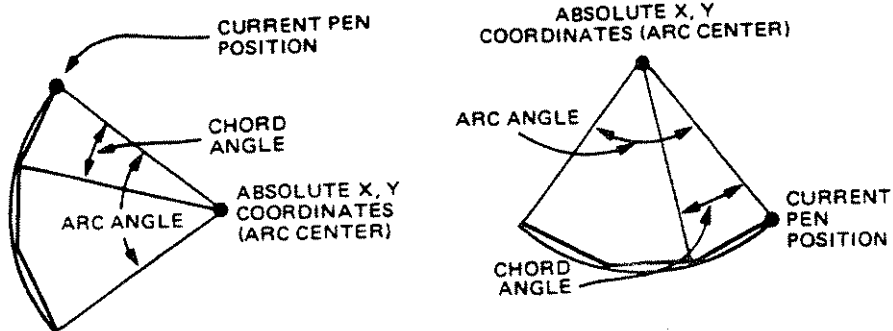

EXPLANATION The AA instruction requires that both X- and Y-coordinates be specified (coordinate pair) in either integer or scaled decimal format. They are interpreted as plotter units if scaling is off or as user units if scaling is on. The X- and Y-coordinates locate the center of the arc and may be located on or off the plotting surface. The current pen position is the starting point of the arc.

The arc angle is in integer format. It is the angle, in degrees, through which the arc is drawn: a positive arc angle draws CCW from the current pen position; a negative arc angle draws CW from the current pen position.

The chord angle parameter is in integer format and governs the smoothness of the arc in the same way as defined under the circle instruction, CI. The sign of the parameter is ignored, except to set the maximum in-range limit to -32768 or $+32767$. The default chord angle is 5 degrees. If you specify a chord length that does not divide the sweep angle into integers, the plotter will compute the chord length up to the nearest integer. Chords are kept the same length.

Unlike circles, arcs are drawn using the previously commanded pen state (up or down) and line type. If no pen state has been commanded since initialization, pen up is assumed. If no line type has been commanded, a solid line is drawn.

Arcs are drawn within the defined window, with clipping occurring outside the window limits. Drawing arcs within the window conforms to the definitions given for plotting under the PA instruction.

All parameters must be in range. Specifying out-of-range parameters sets error 3 and the instruction is ignored.

The following BASIC program demonstrates the use of the AA instruction.

```
10 OPEN "COM1:9600,N,8,1,RS,CS65535,DS,CD" AS #1
20 PRINT #1, "IN;SP1;IP3650,2325,6650,5325;"
30 PRINT #1, "SC0,100,0,100;"
40 PRINT #1, "PA0,20;"
50 PRINT #1, "PD;PA0,40;AA0,50,180;PA0,80;"
60 PRINT #1, "AA0,100,90;PA40,100;AA50,100,180;"
70 PRINT #1, "PA80,100;AA100,100,90;PA100,50;"
80 PRINT #1, "AA100,50,180;PA100,20;"
90 PRINT #1, "AA100,0,90;PA60,0;AA50,0,180;"
100 PRINT #1, "PA20,0;AA0,0,90;PU;PA50,50;CI30;"
110 END
```

- 10 configuration statement; change this statement as necessary for your computer.
- 20, 30 initialize the plotter and establish user-unit scaling.
- 40, 50 move the pen to the point 0,20, lower the pen, and draw to the point 0,40, where a 180-degree arc is drawn counterclockwise, centered at 0,50. The pen is then instructed to draw to the point 0,80.
- 60-90 continue drawing the figure, clockwise, back to the point 0,20, and finish with the circle centered at the point 50,50.

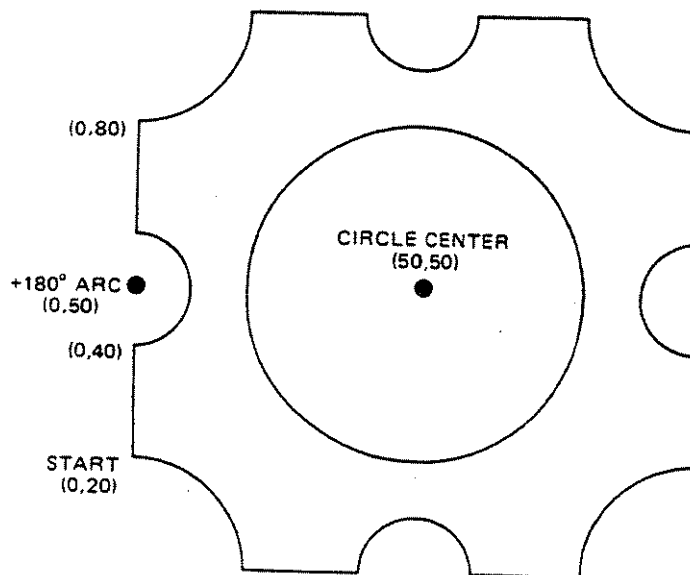

The Arc Relative Instruction, AR

DESCRIPTION The arc relative instruction, AR, provides the means to draw an arc with the center point located relative to the present pen position. The arc can be drawn clockwise (CW) or counterclockwise (CCW), with a specified arc angle and chord angle.

USE The instruction can be used to draw an arc of any radius, length, and smoothness with a single instruction. The arc is drawn from the current pen position, and its center point is located by relative X,Y coordinates.

SYNTAX AR X-increment, Y-increment, arc angle (, chord angle) terminator

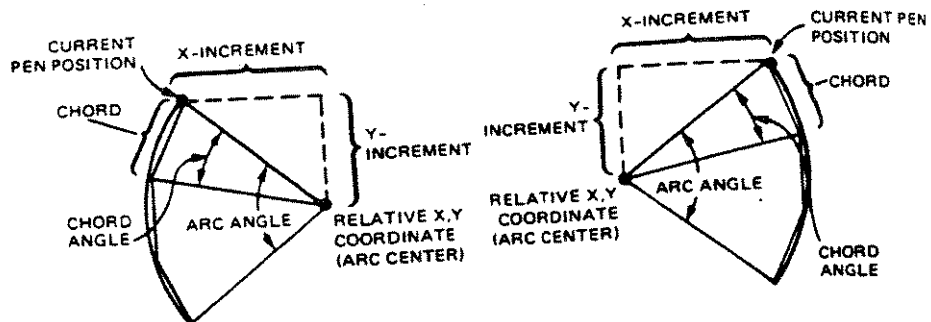

EXPLANATION The AR instruction requires that both X- and Y-increment parameters (coordinate pair) and arc angle be specified. Increment parameters are in integer or scaled decimal format and are interpreted as plotter units if scaling is off or user units if scaling is on. The X- and Y-increment parameters locate the center of the arc with respect to the present pen position. The signs of the increment parameters determine the relative location of the center of the arc. A positive value locates that center in a positive direction and a negative value locates that center in a negative direction. The current pen position is the starting point of the arc.

The arc center can be located on or off the plotting surface. The arc angle is in integer format. It is the angle, in degrees, through which the arc is drawn; a positive arc angle draws CCW; a negative arc angle draws CW.

The chord angle parameter is in integer format and governs the smoothness of the arc in the same way as defined under the circle instruction, CI. The sign of the parameter is ignored, except to set the maximum in-range limit to -32 768 or +32 767. The default chord angle is 5 degrees. If you specify a chord length that does not divide the sweep angle into integers, the plotter will compute the chord length up to the nearest integer. Chords are kept the same length.

Unlike circles, arcs are drawn using the previously commanded pen state (up or down) and line type. If no pen state has been commanded since initialization, pen up is assumed. If no line type has been commanded, a solid line is drawn.

Arcs are drawn within the defined window, with clipping occurring outside the window limits. Drawing arcs within the window conforms to the definitions given for plotting under the PA instruction.

All parameters must be in range. Specifying out-of-range parameters sets error 3 and the instruction is ignored.

The following BASIC programs demonstrate the use of the AR instruction.

```
10 OPEN "COM1:9600,N,8,1,RS,CS65535,DS,CD" AS #1
20 PRINT #1, "IN;SP1;IP3650,2325,6650,5325;"
30 PRINT #1, "SC-100,100,-100,100;"
40 PRINT #1, "PA-80,-50;PD;AR0,80,90;AR80,0,90;PU;"
50 END
```

- 10 configuration statement; change this statement as necessary for your computer.
- 20 enters the P1 and P2 points on which to scale the plotting area.
- 30 scales the plotting area into user units.
- 40 moves the pen to the point $-80,-50$, draws a 90-degree CCW arc centered $0,80$ units relative to the present pen position, then draws a 90-degree arc centered $80,0$ units relative to the $0,30$ absolute pen position. Note that a pen down command, PD, is required to draw the arc.

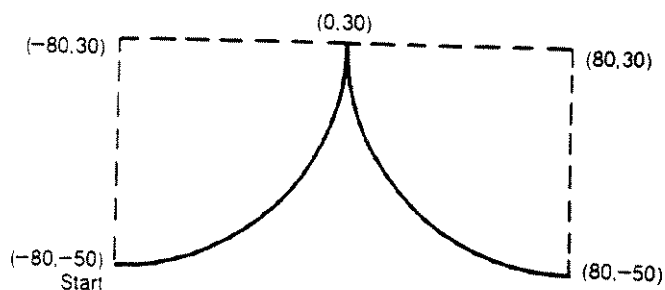

```

10 OPEN "COM:9600,N,8,1,RS,CS65535,DS,CD" AS #1
20 PRINT #1, "IN;SP1;IP3650,2325,6650,5325;"
30 PRINT #1, "SC-100,100,-100,100;"
40 PRINT #1, "PA-100,40;PD;PR50,0;AR0,-40,-90;"
50 PRINT #1, "AR40,0,90;PR50,0;SP0;"
60 END

```

In this example, line 40 moves the pen to the point $-100,40$, lowers the pen, and plots $60,0$ units relative to the previous pen position, $-100,40$. It then draws a 90-degree CW arc centered at $0,-40$ units relative to the new $-40,40$ pen position, and follows it with a 90-degree CCW arc centered $40,0$ units relative to the $0,0$ pen position, the endpoint of the first arc. Finally, it plots $60,0$ units relative to the pen position $40,-40$, the endpoint of the second arc.

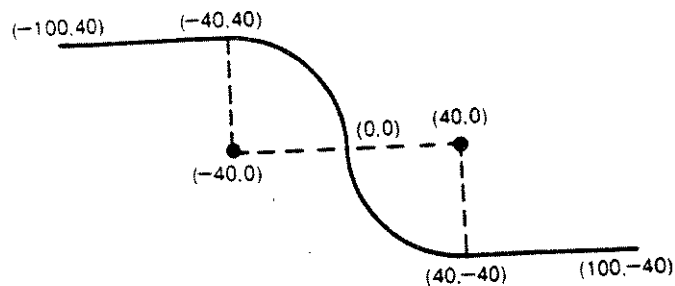

The Fill Type Instruction, FT

DESCRIPTION The fill type instruction, FT, selects the type of area fill for use with an RA, RR, or WG instruction.

USES The instruction can be used to enhance pie charts, bar charts, and other graphs with solid fill, parallel lines, or cross-hatching.

SYNTAX FT (type(, spacing(, angle)))terminator
or
FT terminator

EXPLANATION There are five types of area fill:

1. solid (lines with spacing as defined in the PT instruction; bidirectional shading)
2. solid (lines with spacing as defined in the PT instruction; unidirectional shading)*

*For the highest quality transparencies, use fill type 2.

3. parallel lines
4. cross-hatch
5. ignored

The fill type parameter should always be an integer number between one and four. If you do not specify a type, it will be defaulted to type one. The current pen and line type are used for all fill types, including solid types 1 and 2.

Spacing is the distance between parallel lines in the shade area. The units for spacing are interpreted as plotter units if scaling is off or as user units if scaling is on. The maximum allowable range is between 0 and 32767. If you do not specify spacing, and this is the first FT instruction in your program, the spacing will be defaulted to 1% of the diagonal distance between P1 and P2.

If you do not specify spacing and this is not the first FT instruction in your program, the spacing specified in the previous FT instruction will be used. A spacing value of zero is ignored and the spacing is defaulted to the currently defined pen thickness, PT. The spacing parameter is ignored for solid-fill types 1 and 2, and spacing is determined by the PT instruction.

Determine the angle (line slant) using increments of 45 degrees starting from 0 degrees. Specifying a 0-degree angle will produce horizontal lines, a 90-degree angle will produce vertical lines, and a 45-degree angle will produce angular lines. If you do not specify the angle and this is the first FT instruction in your program, the angle will be defaulted to 0 degrees. If you do not specify the angle and this is not the first FT instruction in your program, the angle specified in the previous FT instruction will be used.

The following list summarizes your FT options:

| Parameter | Number Type | Range | Default |
|-----------|-------------|----------------------------|---|
| fill type | integer | 1-5 | 1 |
| spacing | decimal | 0-32767 (current units) | 1% of the diagonal distance between P1 and P2 |
| angle | integer | ±45° increments from 0 | 0° |

Specifying out-of-range parameters sets error 3 and the instruction is ignored. If you send too many parameters, error 2 is set, the instruction is executed with the first three parameters, and the rest of the parameters are ignored.

A default instruction, DF, or an initialize instruction, IN, will reset the fill type, spacing, and angle to default values.

The Pen Thickness Instruction, PT

DESCRIPTION The pen thickness instruction, PT, determines the spacing between the lines drawn in a solid fill.

USES The instruction can be used with the FT, RR, RA, and WG instructions to produce a solid fill for pie charts and bar graphs.

SYNTAX *PT* pen thickness terminator
or
PT terminator

EXPLANATION The pen thickness is a decimal number representing the physical pen width in millimetres. The range allowed is 0.1 mm-5.0 mm (the optimum range is from 0.3 mm-0.7 mm). If you do not specify a pen thickness, the instruction defaults to the 0.3 mm size. Specifying out-of-range parameters sets error 3 and the instruction is ignored. If you specify too many parameters, the plotter executes the first parameter only, sets error 2 (too many parameters), and ignores the rest of the parameters.

Base the spacing of your lines needed to produce a solid fill on the current physical pen thickness. If your fill has gaps showing between the lines, adjust the pen thickness down. If your pen is getting "fat" through wear, or if you desire improved throughput, adjust the pen thickness upwards.

The PT instruction pertains only to the currently selected pen. It remains in effect only until:

- a. a new pen is selected either through a new SP instruction or manually from the front panel
- b. a new PT instruction is issued.

A default instruction, DF, or an initialize instruction, IN, defaults the pen thickness to 0.3 mm.

The Shade Rectangle Absolute Instruction, RA

DESCRIPTION The shade rectangle absolute instruction, RA, is used to define and shade a rectangle using absolute coordinates.

USES This instruction is used with the FT and PT instructions to fill a rectangle defined by the absolute points specified in the X- and Y-coordinate parameters. For an in-depth discussion of absolute plotting, see the explanation of The Plot Absolute Instruction, PA, in this chapter.

SYNTAX RA X-coordinate, Y-coordinate terminator

EXPLANATION The RA instruction requires that both X- and Y-coordinates be specified (coordinate pair). They are interpreted as plotter units if scaling is off or as user units if scaling is on. The current pen position is the starting point of the rectangle and the X- and Y-coordinates define the opposite corner of the rectangle. The maximum parameters are decimal numbers between -32 768.0000 and 32 767.9999. When scaling is off, the parameters are truncated to integers as follows:

- For positive numbers, the fractional portion is truncated and the integer portion remains unchanged. For example, both 1234.4 and 1234.9 become 1234.
- For negative numbers, the fractional portion is rounded up to the next negative integer. For example, both -1234.4 and -1234.9 become -1235.

An RA instruction with no parameters is ignored but no error is set. Specifying out-of-range parameters sets error 3 and the instruction is ignored. If you specify only one parameter, the instruction is ignored and error 2 is set. If you send too many parameters, the instruction is executed with the first two parameters, error 2 is set, and the rest of the parameters are ignored.

The rectangle is filled using the current pen and line type. At the completion of the instruction, the pen is returned to the original position and the pen state is restored. The following BASIC program demonstrates the use of the RA and FT instructions.

```

10 OPEN "COM1:9600,N,8,1,RS,CS65535,DS,CD" AS #1
20 PRINT #1, "IN;SP1;PA5000,4000;"
30 PRINT #1, "PT.3;FT1;RA4000,3000;"
40 PRINT #1, "FT3,100;RA6000,3000;"
50 PRINT #1, "FT2;RA6000,5000;"
60 PRINT #1, "FT4,100,45;RA4000,5000;"
70 PRINT #1, "SP0;"
80 END

```

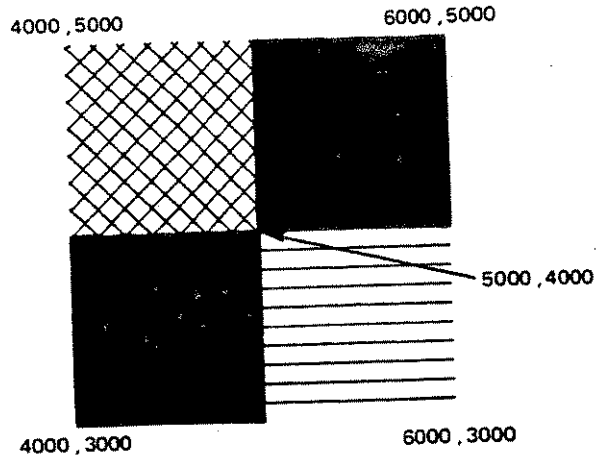

- 10 configuration statement; change this statement as necessary for your computer.
- 20 initializes the plotter, selects a pen (pen 1), and sets the starting position.
- 30 selects pen thickness, fill type 1 (solid fill, bidirectional), and sets the X,Y coordinates for the first rectangle.
- 40 selects the fill type and spacing, and sets the X,Y coordinates for rectangle 2. Notice that you do not need to repeat the pen thickness instruction since it will remain in effect until you select a new pen or a new pen thickness.
- 50 selects the fill type and sets the X,Y coordinates for rectangle 3.
- 60 selects a new fill type, spacing, and angle, and sets the X,Y coordinates for rectangle 4.
- 70 puts the pen back in the carousel.

The Edge Rectangle Absolute Instruction, EA

DESCRIPTION The edge rectangle absolute instruction, EA, edges a rectangle defined in absolute coordinates.

USES This instruction draws the outline of a rectangle. It can be used with the RA instruction to outline a filled rectangle. For an in-depth discussion of absolute plotting, see the explanation of The Plot Absolute Instruction, PA, located in this chapter.

SYNTAX EA X-coordinate, Y-coordinate terminator

EXPLANATION The EA instruction requires that both X- and Y-coordinates be specified (coordinate pair). They are interpreted as plotter units if scaling is off or as user units if scaling is on. The current pen position is the starting point of the rectangle and the X- and Y-coordinates define the opposite corner (diagonal endpoint) of the rectangle. The maximum parameters are decimal numbers between -32768.0000 and 32767.9999. When scaling is off, the parameters are truncated to integers as follows:

- For positive numbers, the fractional portion is truncated and the integer portion remains unchanged. For example, both 1234.4 and 1234.9 become 1234.
- For negative numbers, the fractional portion is rounded up to the next more negative integer. For example, both -1234.4 and -1234.9 become -1235.

An EA instruction with no parameters is not executed but no error is set. Specifying out-of-range parameters sets error 3 and the instruction is ignored. If you send only one parameter, error 2 is set and the instruction is ignored. If too many parameters are specified, then the instruction is executed with the first two parameters, error 2 is set, and the rest of the parameters are ignored.

The plotter will edge the designated rectangle, return the pen to the starting point, and restore the pen status upon completion of the instruction. The following BASIC program demonstrates the use of the EA, RA, and FT instructions.

```
10 OPEN "COM1:9600,N,8,1,RS,CS65535,DS,CD" AS #1
20 PRINT #1, "IN;SP1;PA5000,4000;"
30 PRINT #1, "PT.3;FT1;RA4000,3000;"
40 PRINT #1, "SP3;EA4000,3000;"
50 PRINT #1, "SP4;FT3;RA6000,3000;"
60 PRINT #1, "SP3;EA6000,3000;"
70 PRINT #1, "SP5;FT2;RA6000,5000;"
```

(Program listing continued)

```

80 PRINT #1, "SP3;EA6000,5000;"
90 PRINT #1, "SP6;FT4,100,45;RA4000,5000;"
100 PRINT #1, "SP3;EA4000,5000;"
110 PRINT #1, "SP0;"
120 END

```

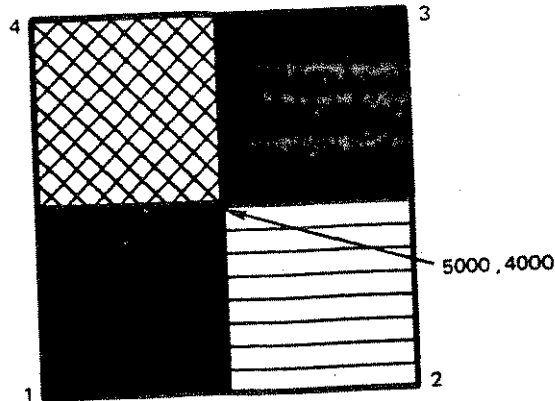

- 10 configuration statement; change this statement as necessary for your computer.
- 20 initializes the plotter, selects a pen (pen 1), and sets the starting position.
- 30 selects pen thickness, fill type 1 (solid fill, bidirectional), and sets the X,Y coordinates for the first rectangle.
- 40 selects a new pen (pen 3) and edges the first rectangle.
- 50 selects a new pen, a new fill type, and sets the X,Y coordinates for rectangle 2.
- 60 selects a new pen and edges rectangle 2.
- 70 selects a new pen, new fill type, and sets the X,Y coordinates for rectangle 3.
- 80 selects a new pen and edges rectangle 3.
- 90 selects a new pen, new fill type, spacing and angle, and sets the X,Y coordinates for rectangle 4.
- 100 selects a new pen and edges rectangle 4.
- 110 puts the pen back in the carousel.

The Shade Rectangle Relative Instruction, RR

DESCRIPTION The shade rectangle relative instruction, RR, can be used to define and shade a rectangle using relative coordinates.

USES This instruction is used with the FT and PT instructions to fill a rectangle defined from a point located relative to the present pen position. For an in-depth discussion of relative plotting, see the explanation of The Plot Relative Instruction, PR, located in this chapter.

SYNTAX RR X-increment, Y-increment terminator

EXPLANATION The RR instruction requires that both X- and Y-increment parameters be specified (coordinate pair). They are interpreted as plotter units if scaling is off or as user units if scaling is on. The current pen position is the starting point of the rectangle and the X- and Y-coordinates define the opposite corner (diagonal endpoint) of the rectangle. As with The Shade Rectangle Absolute Instruction, RA, the maximum parameters are decimal numbers between -32768.0000 and 32767.9999. When scaling is off, the parameters are truncated to integers as follows:

- For positive numbers, the fractional portion is truncated and the integer portion remains unchanged. For example, both 1234.4 and 1234.9 become 1234.
- For negative numbers, the fractional portion is rounded up to the next negative integer. For example, both -1234.4 and -1234.9 become -1235.

An RR instruction with no parameters is ignored but no error is set. Specifying out-of-range parameters sets error 3 and the instruction is ignored. If you specify only one parameter, the instruction is ignored and error 2 is set. If too many parameters are sent, then the instruction is executed with the first two parameters, error 2 is set, and the rest of the parameters are ignored.

The rectangle is filled using the current pen and line type. At the completion of the instruction, the pen is returned to the original position and the pen state is restored. The following BASIC program, similar to the one used under the RA instruction, demonstrates the use of the RR and FT instructions.

```
10 OPEN "COM1:9600,N,8,1,RS,CS65535,DS,CD" AS #1
20 PRINT #1, "IN;SP1;PA5000,5000;"
30 PRINT #1, "PT.3;FT1;RR1000,1000;"
40 PRINT #1, "PR1000,0;"
50 PRINT #1, "FT3,100;RR1000,1000;"
60 PRINT #1, "PR0,1000;"
70 PRINT #1, "FT2;RR1000,1000;"
80 PRINT #1, "FT4,100,45;RR-1000,1000;"
90 PRINT #1, "SP0;"
100 END
```

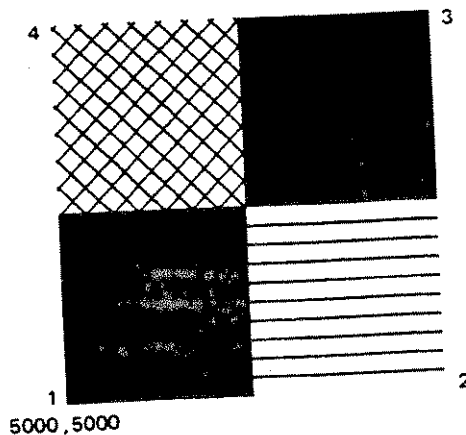

- 10 configuration statement; change this statement as necessary for your computer.
- 20 initializes the plotter, selects a pen (pen 1), and sets the starting position.
- 30 selects pen thickness, fill type 1 (solid fill, bidirectional), and sets the X,Y coordinates for the first rectangle.
- 40 moves the pen relative to its current location by the number of units specified by the X- and Y-parameters.
- 50 selects the fill type and spacing, and sets the X,Y coordinates for rectangle 2.
- 60 moves the pen relative to its current location by the number of units specified by the X- and Y-parameters.
- 70 selects the fill type and sets the X,Y coordinates for rectangle 3. Notice that you do not need to repeat the pen thickness for fill type 2 since it will remain in effect until you select a new pen or a new pen thickness.
- 80 selects the fill type, spacing, and angle and sets the X,Y coordinates for rectangle 4.
- 90 puts the pen back in the carousel.

The Edge Rectangle Relative Instruction, ER

DESCRIPTION The edge rectangle relative instruction, ER, edges a rectangle using relative plotting.

USES This instruction draws the outline of a rectangle. It can be used with the RR instruction to outline a filled rectangle. For an in-depth discussion of relative plotting, see the explanation of The Plot Relative Instruction, PR, in this chapter.

SYNTAX ER X-coordinate, Y-coordinate terminator

EXPLANATION The ER instruction requires that both X- and Y-coordinates be specified (coordinate pair). They are interpreted as plotter units if scaling is off or as user units if scaling is on. The current pen position is the starting point of the rectangle and the X- and Y-coordinates define the opposite corner (diagonal endpoint) of the rectangle. As with The Edge Rectangle Absolute Instruction, EA, the maximum parameters are decimal numbers between -32 768.0000 and 32 767.9999. When scaling is off, the parameters are truncated to integers as follows:

- For positive numbers, the fractional portion is truncated and the integer portion remains unchanged. For example, both 1234.4 and 1234.9 become 1234.
- For negative numbers, the fractional portion is rounded up to the next negative integer. For example, both -1234.4 and -1234.9 become -1235.

An ER instruction with no parameters is not executed but no error is set. Specifying out-of-range parameters sets error 3 and the instruction is ignored. If you send only one parameter, error 2 is set, and the instruction is ignored. If too many parameters are specified, then the instruction is executed with the first two parameters, error 2 is set, and the rest of the parameters are ignored.

The plotter will edge the designated rectangle, return the pen to the starting point, and restore the pen status upon completion of the instruction. The following BASIC program demonstrates the use of the ER, RR, and FT instructions.

```
10 OPEN "COM1:9600,N,8,1,RS,CS65535,DS,CD" AS #1
20 PRINT #1, "IN;SP1;PA5000,5000;"
30 PRINT #1, "PT.3;FT1;RR1000,1000;"
40 PRINT #1, "SP3;ER1000,1000;"
50 PRINT #1, "PR1000,0;"
60 PRINT #1, "SP4;FT3;RR1000,1000;"
70 PRINT #1, "SP3;ER1000,1000;"
80 PRINT #1, "PR0,1000;"
90 PRINT #1, "SP5;FT2;RR1000,1000;"
100 PRINT #1, "SP3;ER1000,1000;"
110 PRINT #1, "SP6;FT4,100,45;RR-1000,1000;"
120 PRINT #1, "SP3;ER-1000,1000;"
130 PRINT #1, "SP0;"
140 END
```

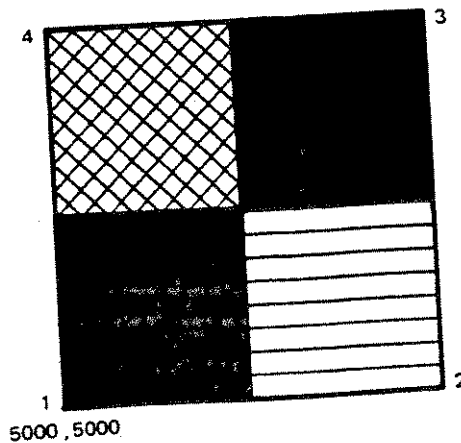

- 10 configuration statement; change this statement as necessary for your computer.
- 20 initializes the plotter, selects a pen (pen 1) and sets the starting position.
- 30 selects pen thickness, fill type 1 (solid fill, bidirectional), and sets the X,Y coordinates for the first rectangle.
- 40 selects a new pen (pen 3) and edges the first rectangle.
- 50 moves the pen relative to its current location by the number of units specified by the X- and Y-parameters.
- 60 selects a new pen, a new fill type, and sets the X,Y coordinates for rectangle 2.
- 70 selects a new pen and edges rectangle 2.
- 80 moves the pen relative to its current location by the number of units specified by the X- and Y-parameters.
- 90 selects a new pen, a new fill type, and sets the X,Y coordinates for rectangle 3.
- 100 selects a new pen and edges rectangle 3.
- 110 selects a new pen, a new fill type, spacing and angle, and sets the X,Y coordinates for rectangle 4.
- 120 selects a new pen and edges rectangle 4.
- 130 puts the pen back in the carousel.

The Shade Wedge Instruction, WG

DESCRIPTION The shade wedge instruction, WG, is used to define and shade any arc segment of a circle of a specified radius.

USES This instruction is used with the FT and PT instructions to produce individual arc wedges that can be combined to create a pie chart. It is also possible to draw triangles, diamonds, pentagons, hexagons, and octagons with this instruction.

SYNTAX WG radius, start angle, sweep angle (,chord angle) terminator

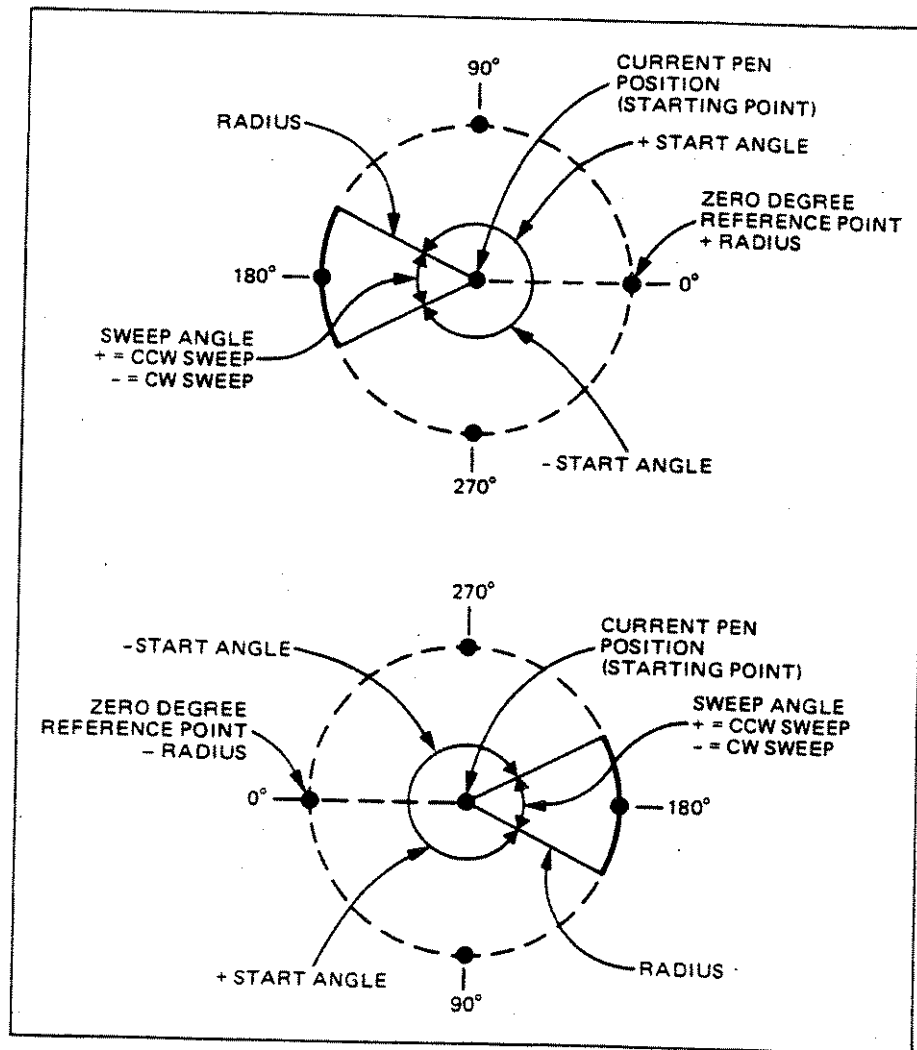

EXPLANATION The WG instruction defines and shades an arc wedge using the current pen and line type. This arc wedge is referenced to the current pen position which should be thought of as the center of a circle.

The radius defines the size of the circle and can be a positive or negative number in integer or scaled decimal format between -32 768.0000 and 32 767.9999. If scaling is off, the radius is in plotter units. If scaling is on, the radius is in X-axis user-units. The sign of the radius defines the zero degree reference point for the start angle and sweep angle.

The start angle is in integer format and defines where the first radius is drawn. A positive start angle positions the radius counterclockwise (CCW) from the zero degree reference point; a negative start angle positions the radius clockwise (CW) from the zero degree reference point. Start angles greater than ± 360 degrees are interpreted modulo 360.

The sweep angle is in integer format between -32 768 and 32 767. The sweep angle defines the number of degrees through which the arc segment is drawn from the start point. A positive sweep angle draws the arc segment CCW; a negative sweep angle draws the arc segment CW. If a sweep angle greater than ± 360 degrees is specified, then a 360-degree angle is used.

The chord angle is in integer format between 1-120 degrees and governs the smoothness of the arc. The smaller the chord angle, the smoother the arc, but the longer it will take to draw. The total number of chords per arc must be limited to 90. If you specify a sweep angle of 360 degrees and you specify a chord angle that is less than 4 degrees, the plotter will use a chord angle of 4 degrees, so that the number of chords will be equal to 90. If you omit the chord angle, it defaults to 5 degrees. If you specify a chord length that does not divide a sweep angle into integers, the plotter will round the chord length up to the nearest integer. Chords are kept the same length. If you use a sweep angle of 360 degrees, a chord length of 120 degrees will produce a triangle; 90 degrees, a diamond; 72 degrees, a pentagon; 60 degrees, a hexagon; and 45 degrees, an octagon.

At the completion of the wedge, the pen is returned to the original position and the pen state is restored.

The following list summarizes your WG options:

| Parameter | Type | Range | Default |
|-------------|---------------------|------------------------------|---------|
| radius | integer/ decimal | -32 768.0000 to +32 767.9999 | none |
| start angle | integer | MOD 360 | none |
| sweep angle | integer | -32 768 to +32 767 | none |
| chord angle | integer | 1-120 | 5° |

A WG instruction with no parameters is not executed but no error is set. Specifying out-of-range parameters sets error 3 and the instruction is ignored.

If you send too few parameters, error 2 is set and the instruction is not executed. If you send too many parameters, error 2 is set, the instruction is executed with the first four parameters, and the rest of the parameters are ignored.

The following BASIC program illustrates the use of the WG instruction.

```

10 OPEN "COM1:9600,N,8,1,RS,CS65535,DS,CD" AS #1
20 PRINT #1, "IN:SP2;FT3;100;"
30 PRINT #1, "PA5000,5000;"
40 PRINT #1, "WG1000,90,180,5;"
50 PRINT #1, "SP4;FT4,100,45;"
60 PRINT #1, "WG1000,270,120;"
70 PRINT #1, "SP1;FT1;"
80 PRINT #1, "WG1000,30,60;"
90 PRINT #1, "SP0;"
100 END

```

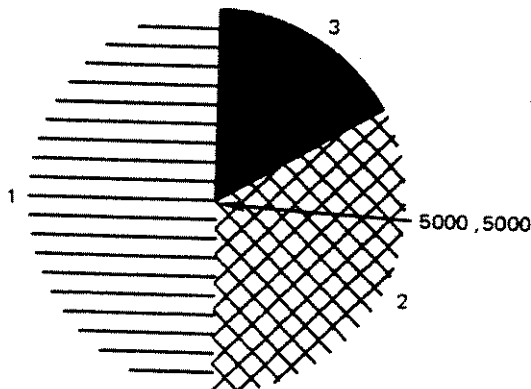

This program produces a circle with three wedges centered at 5000,5000.

| | |
|----|---|
| 10 | configuration statement; change this statement as necessary for your computer. |
| 20 | initializes the plotter and selects a pen, fill type, and spacing. |
| 30 | sets the current pen position. |
| 40 | shades the first wedge with a radius of 1000, sweeping from a 90-degree start angle for 180 degrees with a chord length of 5 degrees. |
| 50 | selects the next pen, fill type, spacing, and angle. |
| 60 | shades the second wedge with a radius of 1000, sweeping from a 270-degree start angle for 120 degrees. No chord length is specified. |
| 70 | selects the next pen and fill type. |
| 80 | shades the third wedge with a radius of 1000, sweeping from a 30-degree start angle to complete the circle. |
| 90 | puts the pen back in the carousel. |

The Edge Wedge Instruction, EW

DESCRIPTION The edge wedge instruction, EW, is used to edge any arc segment of a circle of a specified radius.

USES This instruction is used to produce individual arc segments that can be combined to create a pie chart.

SYNTAX EW radius, start angle, sweep angle (,chord angle) terminator

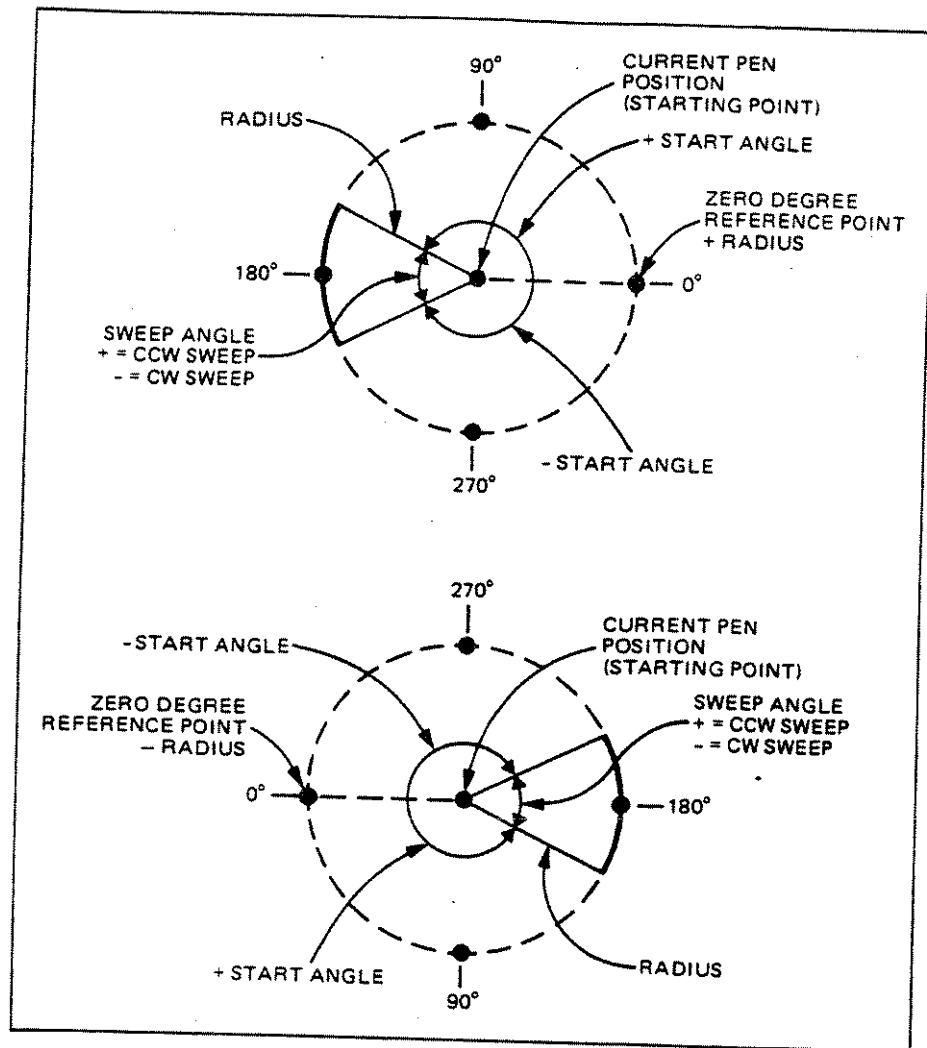

EXPLANATION The EW instruction outlines a wedge using the current pen and line type. This arc wedge is referenced to the current pen position which should be thought of as the center of the circle.

The radius defines the size of the circle and can be a positive or negative number in integer or scaled decimal format between -32 768.0000 and 32 767.9999. If scaling is off, the radius is in plotter units. If scaling is on, the radius is in X-axis user-units. The sign of the radius defines the zero degree reference point for the start angle and sweep angle.

The start angle is in integer format and defines where the first radius is drawn. A positive start angle positions the radius counterclockwise

(CCW) from the zero degree reference point; a negative start angle positions the radius clockwise (CW) from the zero degree reference point.

The sweep angle is in integer format between -32 768 and 32 767. The sweep angle defines the number of degrees through which the angle is drawn. A positive sweep angle draws the arc segment CCW; a negative sweep angle draws the arc segment CW. If a sweep angle greater than ± 360 degrees is specified, then a 360-degree angle is used.

The chord angle parameter is in integer format between 1-120 and governs the smoothness of the edge. For additional information on the chord angle parameter, see The Shade Wedge Instruction, WG, in this chapter.

At the completion of the wedge, the pen is returned to the original position and the pen state is restored.

The following list summarizes your EW options:

| Parameter | Type | Range | Default |
|-------------|---------------------|------------------------------|---------|
| radius | integer/ decimal | -32 768.0000 to +32 767.9999 | none |
| start angle | integer | MOD 360 | none |
| sweep angle | integer | -32 768 to +32 767 | none |
| chord angle | integer | 1-120 | 5° |

An EW instruction with no parameters is not executed but no error is set. Specifying out-of-range parameters sets error 3 and the instruction is ignored. If you send too few parameters, error 2 is set and the instruction is not executed. If you send too many parameters, error 2 is set, the instruction is executed with the first four parameters, and the rest of the parameters are ignored.

The following BASIC program illustrates the use of the EW instruction.

```

10 OPEN "COM1:9600,N,8,1,RS,CS65535,DS,CD" AS #1
20 PRINT #1, "IN;SP1;FT3,100;"
30 PRINT #1, "PA5000,5000;"
40 PRINT #1, "W61000,90,180,5;"
50 PRINT #1, "SP3;EW1000,90,180,5;"
60 PRINT #1, "SP4;FT4,100,45;"
70 PRINT #1, "W61000,270,120;"
80 PRINT #1, "SP3;EW1000,270,120;"
90 PRINT #1, "SP1;FT1;"
100 PRINT #1, "W61000,30,60;"
110 PRINT #1, "SP3;EW1000,30,60;"
120 PRINT #1, "SP0;"
130 END

```

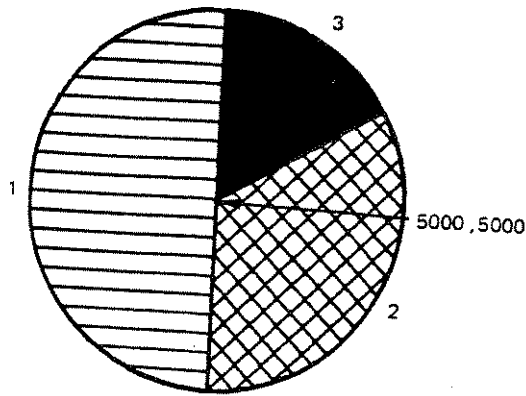

This program produces a circle with three wedges centered at 5000,5000.

```

10      configuration statement; change this statement as nec-
20      essary for your computer.
30      initializes the plotter and selects a pen, fill type, and
40      spacing.
50      sets the current pen position.
60      shades the first wedge with a radius of 1000, sweeping
70      from a 90-degree start angle for 180 degrees with a
80      chord length of 5 degrees.
90      selects a new pen and outlines the first wedge.
100     selects a new pen, fill type, spacing, and angle.
110     shades the second wedge with a radius of 1000, sweep-
120     ing from a 270-degree start angle for 120 degrees.
130     selects a new pen and outlines the second wedge.
140     selects a new pen and fill type.
150     shades the third wedge with a radius of 1000, sweep-
160     ing from a 30-degree start angle for 60 degrees to
170     complete the circle.
180     selects a new pen and outlines the third wedge.
190     puts the pen back in the carousel.

```

Chapter 4

Enhancing the Plot

What You'll Learn in This Chapter

Now that you can draw lines, you are ready to create your own plots. In this chapter you will learn how to enhance your plots by using HP-GL instructions to draw tick marks on axes or create grids, draw a symbol or character of your choice at each data point, and draw dashed or dotted lines. All these enhancements will make your data easier to interpret.

HP-GL Instructions Covered

- XT The X-Tick Instruction
- YT The Y-Tick Instruction
- TL The Tick Length Instruction
- SM The Symbol Mode Instruction
- LT The Line Type Instruction

The Tick Instructions, XT and YT

DESCRIPTION The tick instruction, XT, draws a vertical X-tick at the current location. The tick instruction, YT, draws a horizontal Y-tick at the current pen location.

USES These instructions can be used to draw tick marks on axes, draw grid lines by making the tick length 100%, or draw horizontal or vertical lines either centered on or ending at the current pen position.

SYNTAX XT terminator
or
YT terminator

EXPLANATION Neither instruction requires parameters; numeric parameters set error 2, and the instruction is executed.

The tick mark will be drawn at the current pen position whether the pen is up or down.

The tick length is specified by the tick length instruction, TL. If no tick length is specified, the length defaults to 0.5% of $(P2_x - P1_x)$ for YT or 0.5% of $(P2_y - P1_y)$ for XT for each (positive and negative) portion of the tick. Refer to The Tick Length Instruction, TL, which follows.

The following example draws a horizontal line 3000 plotter units long, places X-ticks at the endpoints and at X-locations 1200 and 2200, and raises and stores the pen.

```
"IN;SP2;PA200,500;PD;XT;PR1000,0;XT;"  
"PR1000,0;XT;PR1000,0;XT;PU;SP0;"
```



The Tick Length Instruction, TL

DESCRIPTION The tick length instruction, TL, specifies the length of the tick marks drawn by the plotter. The tick lengths are specified as a percentage of the horizontal and vertical distances between the scaling points P1 and P2.

USES The instruction can be used to set the length of both positive and negative portions of tick marks. The instruction can be used with only one parameter to suppress the negative portion of a tick mark, or with a first parameter of zero to suppress the positive portion of the tick. Setting the tick length, tp, to 100 enables the user to draw grids easily, using XT and YT instructions.

SYNTAX TL tp (,tn) terminator
or
TL terminator

EXPLANATION Both parameters must be between -128 and +127.9999. Use of positive parameters is recommended. For most applications, parameters will be between 0 and 100.

The up and right tick length, tp, determines the length of the upward portion of the tick marks drawn along the X-axis and the right-side portion of the tick marks drawn along the Y-axis, taking P1 as the lower-left corner.

The down and left tick length, tn, determines the length of the downward portion of the tick marks drawn along the X-axis and the left-side portion of the tick marks drawn along the Y-axis, taking P1 as the lower-left corner.

The values specified by parameters tp and tn are a percentage of the vertical scale length ($P2_y - P1_y$) when used with the XT instruction, and a percentage of the horizontal scale length ($P2_x - P1_x$) when used with the YT instruction. Note the actual tick length is a function of the scaling established by P1 and P2, and the length of ticks on the X- and Y-axes will be different even if the same tick length percentage value is specified for both XT and YT, unless the area defined by P1 and P2 is square.

The plotter, when initialized, automatically sets the tick length values to 0.5% of the scaling lengths ($P2_y - P1_y$) and ($P2_x - P1_x$). A TL instruction with no parameters will default to the same values. A TL instruction with only one parameter specifies the length of tp, and tn will be zero. A negative tp parameter will draw a negative tick just as would be drawn by a tn with a positive parameter. Likewise, a negative tn parameter will draw a positive tick. Use of negative parameters is not recommended both because the results are more difficult to visualize and programs with negative parameters will not be compatible with other HP plotters. A TL instruction remains in effect until another TL instruction with valid parameters is executed or an IN or DF instruction is executed.

The following example draws both tick marks and grid lines. The grid lines are a result of specifying 100% tick length. The horizontal tick marks on the left-most grid line are drawn using the default tp,tn. The tick marks on the second grid line have a positive tick length of 1% and no negative tick. The tick marks on the third grid line have no positive tick and a negative tick length of 5%. Note that these last tick marks are drawn by the YT instruction even though the PU instruction is in effect. However, the moves to the next tick location are made with the pen up, and hence, the grid line is not retraced. A reduced version of the plot follows.

```

10 OPEN "COM1:9600,N,8,1,RS,CS65535,DS,CD" AS #1
20 PRINT #1, "IN;PA300,279;SP2;PD;TL100;XT;"
30 FOR I=1 TO 10
40 PRINT #1, "PR1000,0;XT;"
50 NEXT I
60 PRINT #1, "TL;PU;PA300,279;PD;"
70 GOSUB 1000
80 PRINT #1, "TL1,0;PU;PA1300,279;PD;"
90 GOSUB 1000
100 PRINT #1, "TL0,5;PU;PA2300,279;"
110 GOSUB 1000
120 PRINT #1, "PA300,7479;TL100;YT;PU;SP0;"
1000 REM SUBROUTINE TO DRAW TICKS
1010 FOR J=1 TO 9
1020 PRINT #1, "PR0,720;YT;"
1030 NEXT J
1040 RETURN
1050 END

```

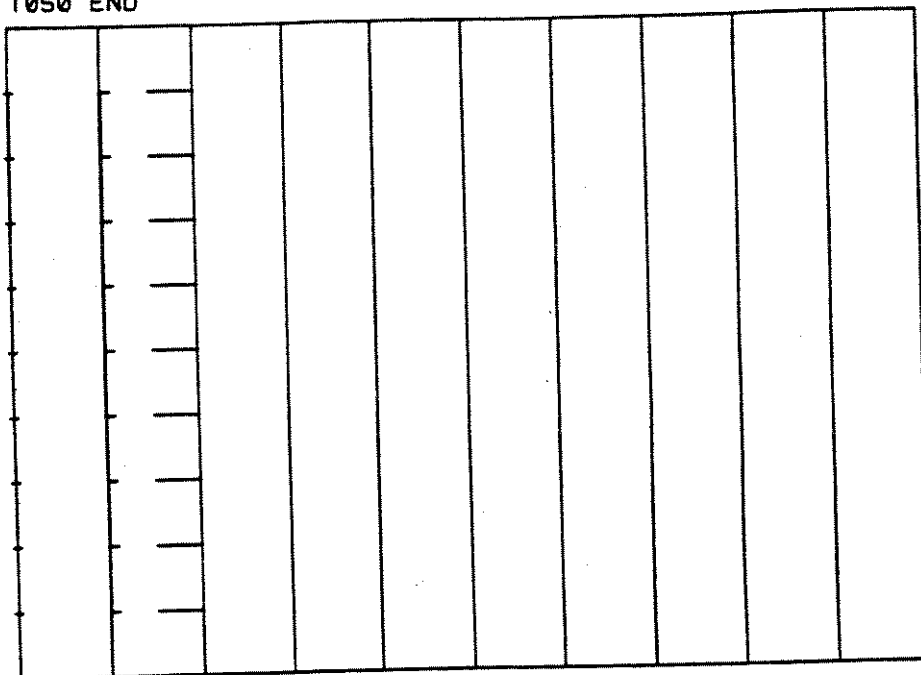

The Symbol Mode Instruction, SM

DESCRIPTION The symbol mode instruction, SM, is used with PA and PR instructions, and provides the means to draw a single character which is centered at the end of each vector.

USES Symbol mode plotting can be used to draw a specified character at each data point and thus to create scattergrams, geometric drawings, or multiple-line graphs where lines are easy to differentiate.

SYNTAX *SM* *c* terminator
or
SM terminator

EXPLANATION An *SM* instruction without parameters turns off symbol mode. When a parameter is present, it is limited to a single character, which must be one of the printing characters of the character set currently selected.

NOTE: Remember that the first character after the mnemonic will be interpreted as the parameter. ■

After an *SM* instruction has been executed, subsequent *PA* and *PR* instructions function as described in the previous chapter, except that the specified symbol mode character is drawn at the end of each vector and is centered on the plotted point. (A character drawn at a point using the label instruction, *LB*, would not be centered on the point.) Drawing of the character is independent of the current pen state (up or down); the character is always drawn at each point specified in the *PA* and *PR* instruction.

The character is drawn according to the character set selected when the *SM* instruction is executed. The character does not change even if a new set is selected. An *SM* instruction remains in effect until another valid *SM* instruction is executed or an *IN* or *DF* instruction is executed. The size (*SI* and *SR*), slant (*SL*), and direction (*DI* and *DR*) instructions affect the character drawn.

An *SM* instruction can specify any printing character (decimal values 33 through 126). The semicolon (decimal value 59) is used only to cancel symbol mode (*SM;*) and cannot be selected as the symbol to be drawn at the endpoint of each vector. Specifying a space (decimal value 32) or any control character also cancels symbol mode.

The following example shows symbol mode plotting with the pen up and the pen down as might be used in line graphs, geometric drawings, and scattergrams.

```
"IN;SP1;SM*;PA200,1000;"  
"PD400,1230,600,1560,900,1670,1500,1600,2000,2000;"  
"PU;SM;PA100,300;SM3;"  
"PA300,500,500,450,900,850,1350,1300,2100,1350;PU;"  
"SM;PA1900,560;PD;SMY;PA3300,1250;"  
"SMZ;PA3500,950;SMX;PA1900,560;PU;SP0;"
```

Plot showing symbol mode:

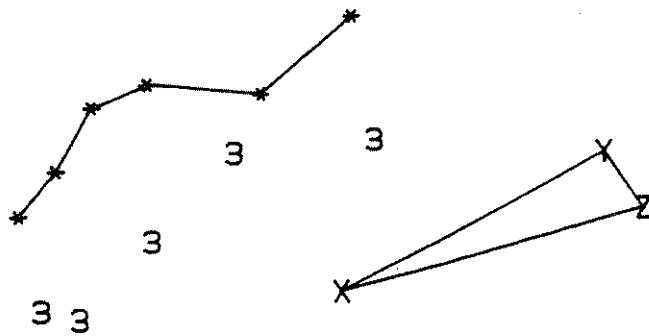

The Line Type Instruction, LT

DESCRIPTION The line type instruction, LT, specifies the type of line that will be used with PA and PR instructions, and for all area fill.

USES This instruction can be used with PA and PR instructions to draw dashed or dotted lines. This facilitates trace differentiation on multiple-line graphs and enables emphasis or deemphasis of plotted lines or grids. One line type causes only dots to be plotted at each data point.

SYNTAX *LT* pattern number (,pattern length) terminator
or
LT terminator

EXPLANATION Shown below are the line patterns and their pattern numbers.

0- specifies dots only at the points that are plotted.

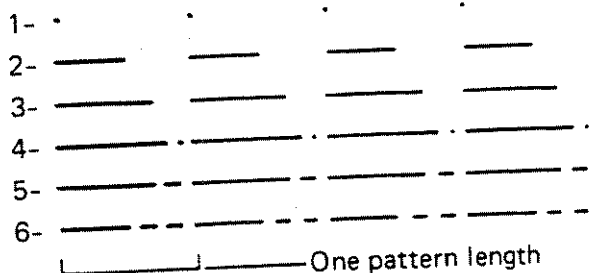

No parameter (Default Value) _____

The shaded portion of each of the line patterns above is one complete segment of the pattern.

The pattern number parameter is in decimal format but is truncated to an integer. This parameter should be between 0 and 6; a parameter in this range sets the line type as shown in the preceding illustration. A parameter in the range 7 to 127.9999 is ignored; the line type does not change and no error is set. A parameter 128 or greater sets error 3 and the line type does not change. A negative parameter between 0 and -128 defaults to a solid line type and no error is set. A negative parameter less than -128 sets error 3 and the line type does not change.

When the first parameter is between 0 and 127.9999, the second parameter is used. This optional pattern length parameter is in decimal format. Both integer and fractional parts are used. This parameter specifies the length of one complete pattern and is expressed as a percentage of the diagonal distance between the scaling points P1 and P2. When this parameter is positive and less than 127.9999, the pattern length is set to this length. When this parameter is negative or is greater than or equal to 128, the previous pattern length is used and error 3 is set. If a pattern length parameter is not specified, a length of 4% is used.

NOTE: If a vector ends in the pen-up portion of the pattern, a pen down instruction, PD, will not physically put the pen down until the next vector instruction is executed and the pen has moved so it is in a pen-down portion of a pattern segment. The pen up instruction clears the carry-over portion of a pattern segment. ■

Chapter 5

Labeling

What You'll Learn in This Chapter

In this chapter you will learn about character sets and labels used to create effective annotated graphics. You will learn how to designate and select character sets, how to use the label instruction with both constant and variable parameters, and how to set the size, slant, and direction of labels. Character spacing, moving the pen any number of character widths and/or lines, and designing your own characters will also be discussed.

HP-GL Instructions Covered

- CS The Designate Standard Character Set Instruction
- CA The Designate Alternate Character Set Instruction
- SS The Select Standard Character Set Instruction
- SA The Select Alternate Character Set Instruction
- DT The Define Terminator Instruction
- LB The Label Instruction
- DI The Absolute Direction Instruction
- DR The Relative Direction Instruction
- CP The Character Plot Instruction
- SI The Absolute Character Size Instruction
- SR The Relative Character Size Instruction
- SL The Character Slant Instruction
- UC The User-defined Character Instruction

Terms You Should Understand

Label Terminator — the final character in every label string; it takes the plotter out of label mode so that characters are no longer drawn but are again interpreted as HP-GL instructions and parameters. Its default value is the ASCII character ETX (decimal equivalent 3), but it may be redefined using the DT instruction.

Character Space Field — the space occupied by a single character, together with the space between it and the next character and the space above the character which separates it from the previous text line.

Label Start Point — the current pen position. Before executing the LB instruction, move the pen to the location where labeling is to begin. You can do this by using, for example, a PA, PR, or CP instruction or by using the front-panel controls.

Plotter Character Sets

The plotter has the capability of lettering with any of 19 internal character sets. Most of the character sets have identical upper- and lowercase alphabetic characters and identical numerals. The symbols and punctuation marks vary from set to set, making annotation in several languages possible. The plotter, when initialized, automatically sets both the standard and alternate character sets to character set 0 which follows:

CHARACTER SET 0

! " # \$ % & ' () * + , - . / 0 1 2 3 4 5 6 7 8 9 : ; < = > ? @
 A B C D E F G H I J K L M N O P Q R S T U V W X Y Z [\] ^ _ ` ~
 a b c d e f g h i j k l m n o p q r s t u v w x y z { | } ~

Some examples of annotation in foreign languages are found below. Notice that the label string in the HP-GL label instruction shows the character in the character set of the keyboard on which the instruction is entered or uses the CHR\$ function if that ASCII character code is not available on the computer's keyboard.

```
*SP2;PA5000,5000;"
*CS33;LB60 & DR"+CHR$(93)+"BER"+CHR$(3)
```

60 & DRÜBER

```
*SP2;PA5000,4000;"
*CS4;LB$su compan"+CHR$(124)+"ia?" +CHR$(3)
```

¿su compañía?

```
*SP2;PA5000,3000;"
*CS30;LB35-50 "+CHR$(93)+"R"+CHR$(3)
```

35-50 ÅR

When using character sets 1-4, the plotter will perform an automatic backspace before drawing an accent above the letter. Therefore, when an accented letter is required, enter the letter first, followed by the accent. When using sets 30-39, these same accented characters are plotted as a single character including the accents.

For a complete listing of all 19 character sets, refer to Appendix C.

The Designate Standard Character Set Instruction, CS

DESCRIPTION The designate standard character set instruction, CS, provides the means of designating one of the 19 character sets (0-4, 6-9, and 30-39) as the standard character set.

USES The instruction can be used to change the standard character set to one with characters appropriate for your application. It is especially useful when labels are in a language other than English.

SYNTAX CS character set number terminator

EXPLANATION The character set number can be 0-4, 6-9, or 30-39. The set designated by the CS instruction is used for all labeling operations when the standard set is selected by the SS instruction or by the control character shift-in (decimal equivalent 15) in a label string. Character set 0 is automatically designated as the standard character set whenever the plotter is initialized or set to default values.

A CS instruction executed while the standard set is selected will immediately change the character set used for labeling. CS instructions executed while the alternate set is selected will not change the set used for labeling until the standard set is selected.

A CS instruction with no parameters defaults to set 0. A CS instruction with invalid parameters sets error 5 (unknown character set), and the instruction is ignored.

The Designate Alternate Character Set Instruction, CA

DESCRIPTION The designate alternate character set instruction, CA, provides the means of designating one of the 19 character sets (0-4, 6-9, or 30-39) as the alternate character set.

USES The instruction can be used to provide an additional character set that can be easily accessed from a program, especially when a single label contains characters found in two different sets.

SYNTAX CA character set number terminator

EXPLANATION The character set number may be from 0-4, 6-9, or 30-39. The set designated by the CA instruction is used for all labeling operations when the alternate set is selected by the SA instruction or by the control character shift-out (decimal equivalent 14) in a label string. Character set 0 is automatically designated as the alternate character set whenever the plotter is initialized or set to default values.

A CA instruction executed while the alternate set is selected will immediately change the character set used for labeling. CA instructions executed while the standard set is selected will not change the set used for labeling until the alternate set is selected.

A CA instruction with no parameters defaults to set 0. A CA instruction with invalid parameters sets an error 5 (unknown character set), and the instruction is ignored.

The Select Standard Set Instruction, SS

DESCRIPTION The select standard set instruction, SS, provides the means of selecting the standard set designated by the CS instruction as the character set to be used for all labeling.

USES The instruction may be used to shift from the currently designated alternate character set to the currently designated standard character set so characters in another set may be accessed. Using the control character shift-in (decimal equivalent 15) inside a label string is equivalent to executing this instruction.

SYNTAX SS terminator

EXPLANATION No parameters are used. Any parameters which follow the instruction set error 2, and the standard set is selected.

The standard ASCII character set (set 0) is automatically selected when the plotter is first turned on, initialized, or set to default values. The standard set can be selected within a label instruction by sending the ASCII control character for shift-in (decimal equivalent 15).

The Select Alternate Set Instruction, SA

DESCRIPTION The select alternate set instruction, SA, provides the means of selecting the alternate set designated by the most recent CA instruction as the character set to be used for all labeling.

USES The instruction may be used to shift from the currently designated standard character set to the currently designated alternate

character set to access characters in a second set. Sending the control character shift-out (decimal equivalent 14) inside a label string is equivalent to executing this instruction.

SYNTAX SA terminator

EXPLANATION No parameters are used. Any parameters which follow the instruction set error 2, and the alternate set is selected.

The instruction should be executed before executing a label statement whenever the alternate character set is to be used. The alternate set can be selected within a label instruction by sending the ASCII control character for shift-out (decimal equivalent 14). Shift-in and shift-out are particularly useful when a line of text must be composed with symbols from two character sets.

The following instruction label using two different character sets where the underline is drawn with and without a backspace. The shift-out character is used to change from the standard to the alternate set.

```
"SP2;PA5000,1000;"
```

```
"CS0;CA4;SS;LBS_E_T_0_" + CHR$(14) + "S_E_T_4_" + CHR$(3)
```

S E T 0 SET4

The Define Terminator Instruction, DT

DESCRIPTION The define terminator instruction, DT, provides the means to specify the character to be used as the label terminator.

USES The instruction can be used to change the label terminator from its default value if ETX (decimal equivalent 3) cannot be used by your computer.

SYNTAX DT t terminator where t is the label terminator.

EXPLANATION The label mode can only be terminated by sending a label terminator at the end of the label character string. ASCII control characters (decimal equivalent 1 through 32 and 127) can be defined as label terminators and will not print when invoked, although the function normally performed by the character will be performed (i.e., LF will terminate a label but will also cause a line feed). ASCII characters with decimal equivalent values 33 through 126 can also be defined as the terminator, but the character will be printed at the end of the label character string. The ASCII control characters NULL (decimal equivalent 0) and ESC (decimal equivalent 27) cannot be used as label terminators. Also, in the RS-232-C environment, ENQ (decimal equivalent 5) is not a valid terminator.

NOTE: A DT instruction with no parameter does not establish ETX as the default terminator, since the character immediately following the mnemonic DT is taken as a parameter. Only a DF or IN instruction or use of the ETX character itself as the instruction's parameter can be used to reestablish ETX as the label terminator. ■

The following examples of text in a label command demonstrate the use of the label terminator.

NOTE: Remember to use the equivalent code for your computer whenever you encounter the ASCII Code, ETX, in a program. On all HP Series 80 computers, use CTRL C. On many other computers, you can use CHR\$(3). ■

```
"IN;SP2;SC0,5000,0,5000;PA0,4500;"
"LBDefault control character ETX"+
CHR$(10)+CHR$(13)+CHR$(3)
"LBterminates by performing end-"+
CHR$(10)+CHR$(13)+CHR$(3)
"LBof-text function."+CHR$(3)
"PA0,3900;DT#;
"LBPrinting characters terminate,"+
CHR$(10)+CHR$(13)+"#"
"LBbut are also printed.#"
```

Default control character ETX
terminates by performing end-
of-text function.

Printing characters terminate,
#but are also printed.#

The Label Instruction, LB

DESCRIPTION The label instruction, LB, provides the means to letter text, expressions, or string variables using the currently defined character set.

USES The label instruction can be used to annotate graphs or create text-only overhead transparencies.

SYNTAX *LB* c...c t

where t is the label terminator, either the default ETX character (decimal equivalent 3), or another character defined by the DT instruction.

EXPLANATION All printing characters following the LB mnemonic are drawn using the currently selected character set. The set used is specified by the CA or CS instructions and selected by the SA or SS instructions, or the ASCII control characters shift-out or shift-in (decimal equivalent 14 and 15 respectively). If not specified, the default character set (set 0) is used.

The direction, size, and slant of the characters assume default values if not previously specified by DI, DR, SI, SR, or SL instructions.

The label mode can be terminated only by sending a label terminator at the end of the character string. Refer to The Define Terminator Instruction. (With an HP-IB interface, the bus instructions interface clear IFC, device clear DCL, or selected device clear SDC will also terminate label mode. Refer to Bus Instructions, Chapter 10.) Unless a label string is terminated, subsequent HP-GL instructions will appear as labels in your plot.

field are normally sent as leading blank spaces to establish fixed spacing between label strings. For close spacing of label strings, the blank spaces can normally be suppressed by substituting a semicolon as a separator between variables.

The following example illustrates use of the comma to establish fixed spacing when using variables for labeling. When the value of X is 50, the labels shown are produced by the given HP-GL instructions. The first statement causes the plotter to label the value of X, X+1, and X+2. Blank spaces between the printed integers normally include space for the sign which may or may not be printed depending on your computer. The number of blank character-field spaces may vary with different computers.

```
PRINT #1, "LB",X,X+1,X+2,+CHR$(3)
```

50 51 52

Blank character field spaces

The diagram shows three labels: 50, 51, and 52. Brackets are drawn below the labels to indicate the spacing between them. A long bracket spans from the start of '50' to the end of '52'. A shorter bracket spans from the start of '51' to the end of '52'. A vertical line points from the text 'Blank character field spaces' to the space between '50' and '51'.

The following example illustrates the closer spacing achieved in BASIC when semicolons separate variables in labeling commands. The semicolons between the variables cause suppression of blank spaces. The space between the printed integers varies with different computers, but normally includes the sign space.

```
PRINT #1, "LB";X;X+1;X+2;+CHR$(3)
```

50 51 52

Any spaces required to fit into the context of the item being labeled must normally be sent enclosed in quotes. The following example labels the same variables as above, but with four extra spaces between each of the integers. Note that four spaces enclosed in quotes are sent between each variable, but the semicolon suppresses unwanted blank spaces.

```
PRINT #1, "LB";X;"       ";X+1;"       ";X+2;+CHR$(3)
```

50 51 52

Four extra spaces

The diagram shows three labels: 50, 51, and 52. Brackets are drawn below the labels to indicate the spacing between them. A long bracket spans from the start of '50' to the end of '52'. A shorter bracket spans from the start of '51' to the end of '52'. A vertical line points from the text 'Four extra spaces' to the space between '50' and '51'.

The Absolute Direction Instruction, DI

DESCRIPTION The absolute direction instruction, DI, specifies the direction in which characters are lettered.

USES The instruction can be used to change the direction of labeling to a new absolute direction; by absolute we mean independent of P1,P2 settings. It is especially useful for labeling a Y-axis or labeling a vertical graph.

SYNTAX DI run, rise terminator
or
DI terminator

EXPLANATION Run and rise are in decimal format, -128 to 127.9999, and specify the direction according to the relationship:

$$\theta = \tan^{-1} \left(\frac{\text{rise}}{\text{run}} \right)$$

where:

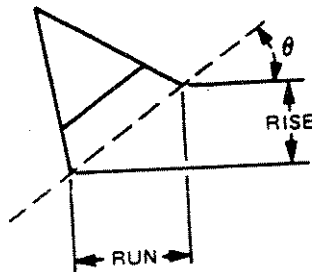

$$\begin{aligned} \text{rise} &= \text{SIN}(\theta) \\ \text{run} &= \text{COS}(\theta) \end{aligned}$$

At least one parameter must be effectively nonzero, i.e., $|\geq 0.0004|$.

A DI instruction with a rise parameter of zero will produce horizontal labeling. A DI instruction with a run parameter of zero will produce vertical labeling.

A DI instruction with no parameters will default to the values DI 1,0 (horizontal). A DI instruction with only one parameter will set error 2, and the instruction will be ignored. A DI instruction with more than two parameters will set error 2, and the instruction will be executed.

A change in the orientation of P1 and P2 will not affect the direction of labeling. A DI instruction remains in effect until another DI or DR instruction, an IN or DF instruction is executed, or the plotter is initialized from the front panel.

A DI instruction updates the carriage-return point to the current pen position.

When the angle, θ , necessary to establish the desired label direction is known, the instruction $DI \cos\theta, \sin\theta$ can be used to establish label direction.

The following example labels the years 1984 through 1991, in a circular pattern starting with vertical labeling. The direction in which each year is labeled is changed by 45 degrees. Then the labels in the center are drawn to illustrate the use of cosine and sine values as parameters. The label `_*_2000` contains both a carriage return and a line feed character before the label terminator, `ETX`, so the pen position at the end of that label is one line below the beginning of that label. The fact that `DI` instructions update the carriage return point can be clearly seen by observing the pen's position at the end of the program. The final character in the last label is a carriage return and the pen returns to the carriage return point, the position of the pen at the last `DI` instruction.

NOTE: Check the format of the `COS` and `SIN` functions on your computer, and change these accordingly. Also, check your computer documentation to see how your computer interprets angles. If angles are interpreted as radians, you need to change to degrees before using the `COS` and `SIN` functions. On the HP Series 80 computers, execute the BASIC statement `DEG`. ■

```
10 OPEN "COM1:9600,N,8,1,RS,CS65535,DS,CD" AS #1
20 PRINT #1, "IN:SP2:PA1050,4450;"
30 PRINT #1, "DI0,1;LB_ _1984"+CHR$(3)
40 PRINT #1, "DI1,1;LB_ _1985"+CHR$(3)
50 PRINT #1, "DI1,0;LB_ _1986"+CHR$(3)
60 PRINT #1, "DI1,-1;LB_ _1987"+CHR$(3)
70 PRINT #1, "DI0,-1;LB_ _1988"+CHR$(3)
80 PRINT #1, "DI-1,-1;LB_ _1989"+CHR$(3)
90 PRINT #1, "DI-1,0;LB_ _1990"+CHR$(3)
100 PRINT #1, "DI-1,1;LB_ _1991"+CHR$(3)
110 PRINT #1, "PA1500,S350;"
120 PI=3.141593
130 A=COS(0*(PI/180))
140 B=SIN(0*(PI/180))
150 PRINT #1, "DI";A;",";B;";"
160 PRINT #1, "LB_ *_2000"+CHR$(10)+CHR$(13)+CHR$(3)
170 C=COS(-45*(PI/180))
180 D=SIN(-45*(PI/180))
190 PRINT #1, "DI";C;",";D;";"
200 PRINT #1, "LB_RETURN POINT"+CHR$(13)+CHR$(3)
210 PRINT #1, "SP0;"
220 END
```

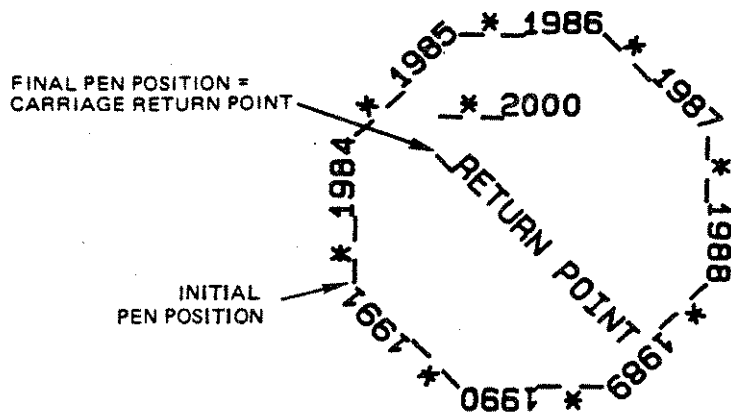

The Relative Direction Instruction, DR

DESCRIPTION The relative direction instruction, DR, specifies the direction in which characters are lettered.

USES The instruction can be used to change the direction of lettering from its default direction, horizontal, to a direction relative to P1,P2. It is useful when creating graphs to be plotted in several sizes and you want labels to have the same relationship to the data on all plots.

SYNTAX DR run,rise terminator
or
DR terminator

EXPLANATION Run and rise are in decimal format, -128 to 127.9999, and specify the label direction according to the relationship:

$$\theta = \tan^{-1} \frac{\text{rise}}{\text{run}}$$

where:

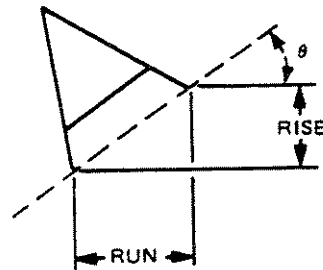

$$\begin{aligned} \text{rise} &= \text{SIN}(\theta) \\ \text{run} &= \text{COS}(\theta) \end{aligned}$$

Run and rise specify a percentage of the algebraic distance between P1 and P2 where run is the desired percentage (-128 to 127.9999) of $P2_x - P1_x$, rise is the desired percentage (-128 to 127.9999) of $P2_y - P1_y$, and P1 and P2 are the scaling points.

If you imagine the current pen position to be the origin, the sign of the parameters determines in which quadrant the lettering will be. In the example on the next page, rise and run assume all combinations of ± 1 with default P1 and P2.

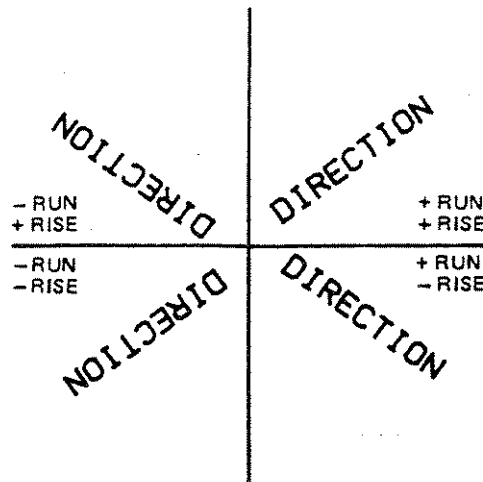

A change in P1 or P2 will affect the direction of lettering. Refer to the section Parameter Interaction in Labeling Instructions.

A DR instruction remains in effect until another DR or DI instruction or an IN or DF instruction or front-panel initialization is executed.

A DR instruction with no parameters will default to the values DR 1, 0 (horizontal).

Specifying both parameters as zero will set error 3, and the instruction will be ignored. Specifying only one parameter will set error 2, and the instruction will not be executed. Specifying more than two parameters will set error 2, and the instruction will be executed.

Spacing Between Characters

Character spacing and line spacing are functions of character size. In the diagram below, you can see the relative position of a character, in this case M, within the character space. The character-space field is set indirectly by the SI instruction, since the character space height is twice the character's height and the character-space width is $1\frac{1}{2}$ times the character's width. The space above and beside a drawn character becomes the spacing between lines and characters. The character space is illustrated on the next page.

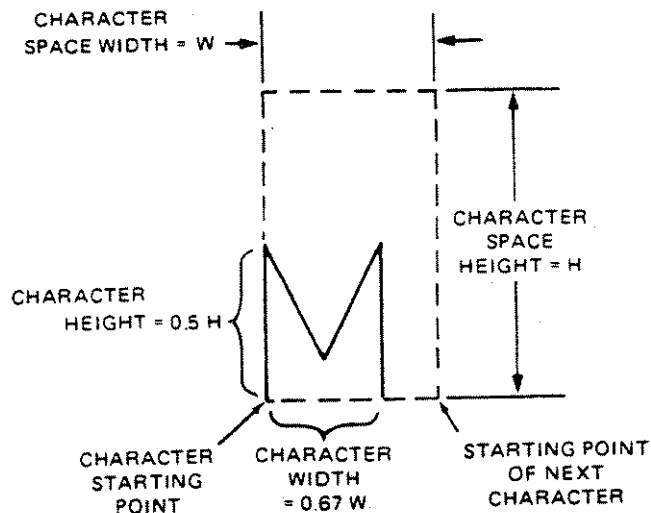

When you specify the height of a character in an SI or SR instruction, however, you should specify the character height, not the height of a character space.

The Character Plot Instruction, CP

DESCRIPTION The character plot instruction, CP, moves the pen the specified number of character-space fields.

USES The instruction can be used to move the pen any number of character spaces or lines from a point on the plotting surface, to align with a left-hand margin, or to center or right-justify a label. Thus, the label can be moved slightly above or below a line, spaces or lines can be inserted in text, or labels can be centered.

SYNTAX CP # of character-space-field widths, # of character-space-field heights terminator
or
CP terminator

EXPLANATION If no parameters are specified, a CP instruction performs a carriage return and line feed, moving one character-space-field height down and returning to the margin defined by the carriage-return point. The carriage-return point is the last point moved to using, for example, a PA, PR, PU, or PD instruction or front panel controls, or the pen position at the last DI or DR instruction. Refer to The Label Instruction in this chapter.

The first parameter specified in the CP instruction moves the pen the specified number of character-space-field widths to the right (a positive value) or the left (a negative value). The second parameter moves the

pen the specified number of character-space-field heights up (a positive value) or down (a negative value). Note that right, left, up, and down are relative to label direction. This is shown below.

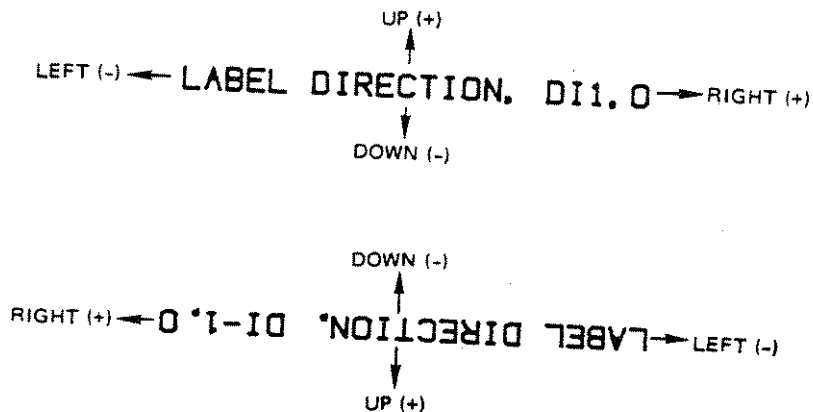

The pen's position (raised or lowered) does not change when a CP instruction is executed.

The use of the CP instruction to produce lettering along a line, but not on top of it and alignment with a left-hand margin is illustrated in the following program. The CP instruction in the second line moves the label slightly above the line. The CP instruction in the third line moves the label slightly below the line and the CP instruction in the last line performs a carriage return, line feed to the margin established by the plot instruction in the second line. Inserting carriage return and line feed characters directly into the label string in the third line causes the same effect as the CP; instruction in the last line. If the carriage return and line feed characters are available on your keyboard, you may prefer that method.

```
"IN;SP1;PA4000,7000;PD1000,7000;PU;"
"CPS,.35;LBAbove THE LINE"+CHR$(3)+"PA2000,7000;"
"XT;CP0,-.95;"
"LBbELOW THE LINE"+CHR$(10)+CHR$(13)+CHR$(3)
"LBAND WITH A NEAT"+CHR$(3)
"CP;LBMARGIN"+CHR$(3)+"SP0;"
```

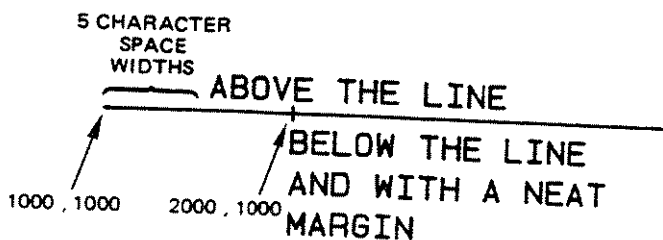

The Absolute Character Size Instruction, SI

DESCRIPTION The absolute character size instruction, SI, specifies the actual size of characters and symbols in centimetres.

USES The instruction can be used to change the character size from its default value or to another value and establish absolute character sizing in centimetres so character size is not dependent on the settings of P1 and P2.

SYNTAX *SI* width, height terminator
or
SI terminator

EXPLANATION If parameters are included, two parameters are required, width and height. The defined width and height are interpreted as centimetres, must be in decimal format, and may have any value between -128 and 127.9999.

| Paper Size | Width | Height |
|------------|---------|---------|
| A/A4 | .187 cm | .269 cm |
| B/A3 | .285 cm | .375 cm |

An SI instruction remains in effect until another valid SI or SR instruction is executed or the plotter is initialized or set to default conditions. An SI instruction with only one parameter sets error 2, and the instruction is not executed. An SI instruction with more than two parameters sets error 2, and the instruction is executed.

The following example draws the plotter's model number, 7475A, at the specified width of 1 cm and height of 1.5 cm.

```
"SI1,1.5;LB7475A"+CHR$(3)
```

7475A

Negative SI parameters will produce mirror images of labels. A negative SI width parameter will mirror labels in the right-to-left direction.

INSTRUCTION
"SI-.35,.6;LBHP"+CHR\$(3)

RESULTING LABEL

PH

A negative height parameter will mirror labels in the top-to-bottom direction.

| INSTRUCTION | RESULTING LABEL |
|----------------------------|-----------------|
| "SI-.35,-.6;LBHP"+CHR\$(3) | Hb |

Two negative SI parameters will mirror the label in both directions and the label will appear to be rotated 180 degrees.

| INSTRUCTION | RESULTING LABEL |
|-----------------------------|-----------------|
| "SI-.-35,-.6;LBHP"+CHR\$(3) | hB |

For further information on the effects of negative parameters, refer to the section Parameter Interaction in Labeling Instructions later in this chapter.

To produce legible characters, parameters should be greater than 0.1. Parameter values above 18 allow no more than two characters to be drawn on the paper.

The Relative Character Size Instruction, SR

DESCRIPTION The relative character size instruction, SR, specifies the size of characters and symbols as a percentage of the distance between scaling points P1 and P2.

USES The instruction can be used to define character size relative to the distance between P1 and P2 so that if the P1,P2 distance changes, character size will adjust to occupy the same "relative" amount of space.

SYNTAX SR width, height terminator
or
SR terminator

EXPLANATION If parameters are included, two parameters are required, width and height. The defined width and height are interpreted as a percentage of the algebraic distance between the X- or Y-coordinates of P1 and P2. The parameters are in decimal format and may have any value between -128 and 127.9999. An SR instruction with no parameters will default to the values 0.75 for width and 1.5 for height, which, when P1 and P2 are at default values, produces letters the same size as an SI instruction without parameters.

An SR instruction remains in effect until another valid SR or SI instruction is executed or the plotter is initialized or set to default conditions. An SR instruction with only one parameter sets error 2, and the instruction is ignored. An SR instruction with more than two parameters sets error 2, and the instruction is executed.

The following example shows how changes in P1 and P2 affect labels drawn while an SR instruction is in effect. The upper label is written with default character size. Then P1 and P2 are changed to define a square area with 6000-plotter-unit sides. A new label is drawn. Next a new SR instruction is executed with both width and height parameters set to three percent. Because the area established by P1 and P2 is square, equal parameters create square letters. With default P1 and P2 settings, equal parameters do not create square letters.

```
"IN;SP1;PA100,7000;LBDEFAULT SIZE"+CHR$(3)
"IP1000,1000,7000,7000;PA100,6500;"
"LBNEW P1 AND P2 CHANGE LABEL SIZE"+CHR$(3)
"SR2.5,2.5;PA100,6000;"
"LBNEW SR INSTRUCTION"+CHR$(10)+CHR$(13)
"CHANGES LABEL SIZE"+CHR$(3)
```

DEFAULT SIZE

NEW P1 AND P2 CHANGE LABEL SIZE

NEW SR INSTRUCTION
CHANGES LABEL SIZE

Either negative SR parameters or switching the relative positions of P1 and P2 will produce mirror images of labels. Refer to The Absolute Size Instruction, SI, and Parameter Interaction in Labeling Instructions for more information on mirroring.

With default P1 and P2, the useful range of width and height parameters which produces legible characters and a label of suitable length is approximately 0.6 to 5 percent.

The Character Slant Instruction, SL

DESCRIPTION The character slant instruction, SL, specifies the slant with which characters are lettered.

USES The instruction may be used to create slanted text, particularly for emphasis, or to reestablish upright labeling after an SL instruction with parameters has been in effect.

SYNTAX *SL* tan θ terminator
 or
SL terminator

EXPLANATION The instruction may be used with or without a parameter. When a parameter is included, it is interpreted as the tangent of the angle from vertical as shown below. Additional parameters following the first parameter are ignored, set error 2, and the instruction is executed. An *SL* instruction without parameters defaults to the same value as *SL0*, and labels are not slanted.

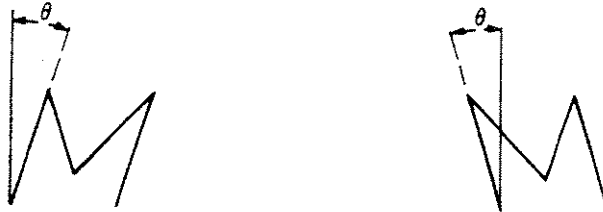

The useful parameter range is ± 0.05 to ± 2 when using default-size characters and up to ± 3.5 for large letters.

An *SL* instruction remains in effect until an *IN*, *DF* or new *SL* instruction is received or the plotter is initialized from the front panel.

The following example letters *HP* at a slant of +45 degrees and -45 degrees.

```
"DF;SP1;SI.75,1.;PA3000,6000;"
"SL1;LBAT&T"+CHR$(3)
"SL-1;PA3000,5000;LBAT&T"+CHR$(3)
```

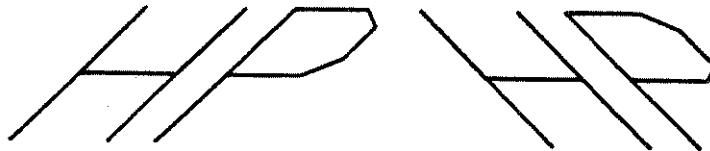

The User-Defined Character Instruction, UC

DESCRIPTION The user-defined character instruction, *UC*, provides the means to draw characters of your own design.

USES This instruction is used to create symbols not included in the plotter's character sets, to draw logos, or to create your own character fonts.

SYNTAX UC (pen control,)X-increment,Y-increment,(pen control,)
 (X-increment,Y-increment,) terminator
 or
 UC terminator

EXPLANATION Each segment of the character is drawn on a character grid. This grid is established on each character-space field by dividing it into 6 horizontal units and 16 vertical units. The size of the character-space field and, hence, the grid unit is set by the current size instruction. The size of the character-size space field and, thus, the grid is always twice the current character height and 1½ times the current character width. To draw a user-defined character the same size as a character drawn with a label instruction, design the user-defined character in the lower-left corner of the grid with a width of four grid units and a height of eight grid units.

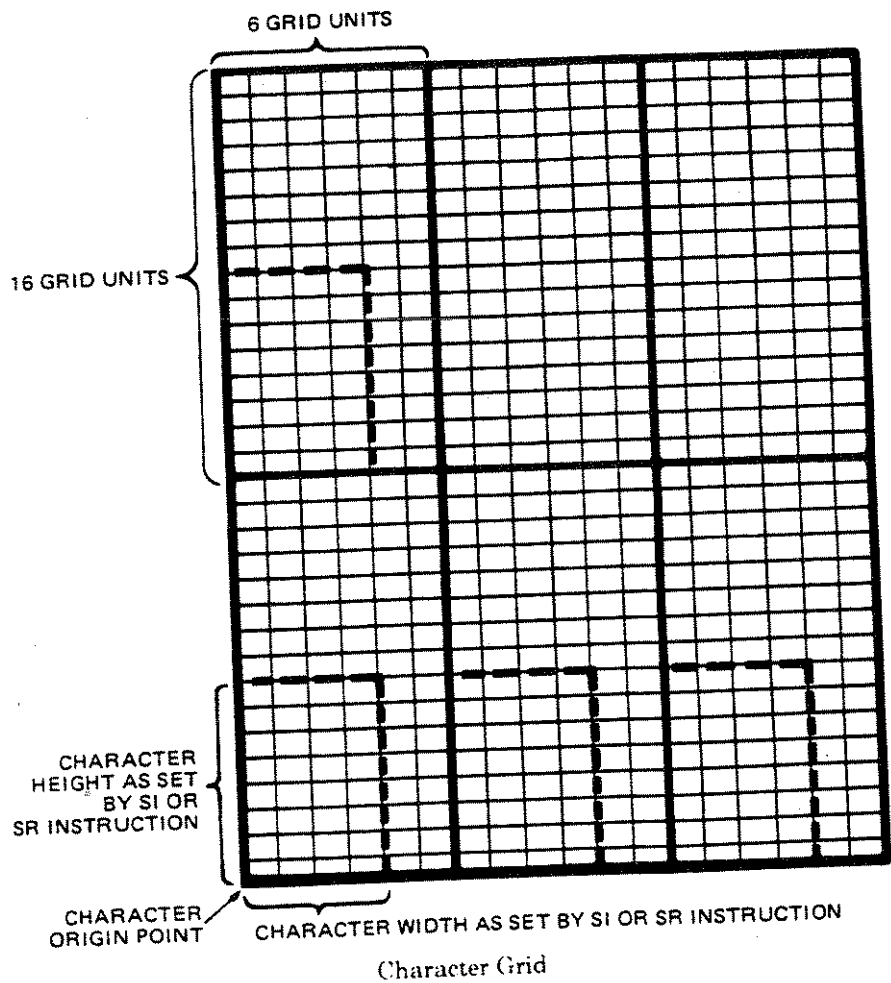

A user-defined character is drawn in the following manner:

1. Each X,Y increment is drawn using the pen up/down status of the most recent pen control parameter. Upon entry into a UC instruction, the plotter sets the pen status up and the pen at the point 0,0 on the character grid.
2. The pen moves to the point defined by each X,Y increment pair in order. The X- and Y-increments should appear in pairs and must be greater than -99 and less than +99. The X-increment specifies in decimal format (-98.9999 to +98.9999) the number of primitive grid units that the pen will move horizontally from the current pen position. A positive increment causes the pen to move to the right, and a negative increment causes it to move to the left.

The Y-increment specifies in decimal format (-98.9999 to +98.9999) the number of character grid units that the pen will move vertically from the current pen position. A positive increment moves the pen up, and a negative increment moves the pen down. All references to the right, left, up, and down are relative to the current label direction. UC characters are mirrored in the same way as labeled characters. Unmatched X,Y increments are discarded, error 2 is set, and the rest of the character is drawn.

3. The pen control parameter is specific to the UC instruction. The pen control parameters are as follows:

Integers > +99 interpreted as pen down

Integers < -99 interpreted as pen up

Integers > +127.9999 or < -128 sets error 3 (out-of-range parameter)

Since the plotter sets the pen status to up, nothing will be drawn by a UC instruction which does not have at least one pen down parameter. A UC instruction without a pen down parameter will result in a pen movement of one character-space field horizontally. A UC instruction with no parameters causes the pen to return to the carriage return point. Once a pen down parameter is specified, the pen remains down for the following X,Y increment moves until a pen up parameter is specified or a UC instruction is completed. Upon termination of the UC instruction, the pen is raised and moves to the next character origin. The pen then assumes the status (up or down) of the most recent PU and PD instruction.

The position of the pen when the UC instruction is executed becomes the character origin point. The initial X,Y increment is relative to the character origin point, and each subsequent move is relative to the last commanded pen position. Upon completion of the user-defined character, the pen is automatically moved one character-space field to the right of the character origin point. This point becomes the current pen position and, hence, the character origin point for the next character (if any).

The following example generates a Σ symbol which is the same size as an uppercase letter. For comparison, an "E" is drawn with the label instruction. The example shows how size instructions affect both user-defined characters and labeled characters. The HP-GL instructions appear in quotation marks in the BASIC PRINT statements. Other BASIC statements, FOR and NEXT, are included in this example.

```

20 PRINT #1, "IN;SP1;PA1000,1000;"
30 FOR A=.19 TO .89 STEP .1
40 PRINT #1, "SI",A,A*1.4
50 PRINT #1, "UC4,7,99,0,1,-4,0,2,-4,-2,-4,4,0,0,1;"
60 NEXT A
70 PRINT #1, "PA1000,1750;"
80 FOR B=.19 TO .89 STEP .1
90 PRINT #1, "SI",B,B*1.4
100 PRINT #1, "LBE"+CHR$(3)
110 NEXT B

```

EEEEEEEE E
 $\Sigma\Sigma\Sigma\Sigma\Sigma\Sigma\Sigma$

User-defined characters need not fit into a single character-space field. In the next example, the user-defined character takes up more than one character space. Since this character is to be followed by a label, a CP instruction must be added to move the current pen position beyond the limits of the user-defined character. The reference point for parameters of CP instructions is the pen position at the completion of the user defined character, one character-space field to the right of the origin of the user-defined character.

```

"IN;SP1;PA1000,5000;SI.25,.4;"
"UC0,4,99,1.75,0,1.5,4,3,-8,3,8,3,-8,3,8,
3,-8,1.5,4,1.75,0;"
"CP3.25,0;LB1000 ohms"+CHR$(3)

```

 1000 ohms

User-defined characters are drawn using the current character size, slant, and direction. It is also possible to change the size of a user-defined character by changing each X- or Y-increment parameter by a

constant multiple. Send the following instructions to the plotter. The resistor drawn will be twice the size of the resistor drawn in the last example.

```
"IN;SP1;PA1000,4500;SI.25,.4;"  
"UC0,8,99,3.5,0,3,8,6,-16,6,16,6,-16,6,16,  
6,-16,3,8,3.5,0;"
```



Parameter Interaction in Labeling Instructions

There are three factors which interact and affect the direction and mirroring of labels; the label direction as specified by DI or DR instructions or default direction, the sign of the parameters for the size instructions SI or SR, and the relative positions of P1 and P2. These interactions are complex. This section considers the four possible combinations of DI, DR, SI, and SR and illustrates the effects of various parameters and settings of P1 and P2 on labels.

The labels used in the illustrations are the instructions which cause the direction, size, and mirroring of the label. All descriptions are in terms of the standard X,Y coordinate system. An arrow is shown for each label; this arrow is the baseline along which labeling occurs and shows the left-to-right direction that is the standard direction of a label without mirroring. The same P1,P2 area, that area set by default P1 and P2, is always used. During the course of the illustrations, P1 and P2 are assigned to opposite corners of this rectangle in all possible ways. The values used for X-coordinates of P1 and P2 are 250 and 10250; the values used for the Y-coordinates of P1 and P2 are 596 and 7796.

Use of DI and SI

When DI and SI instructions are used together, the DI instruction establishes the label's direction and the SI instruction establishes its size. The direction serves as the axis along and about which labels (written with negative SI parameters) are mirrored. Positions of P1 and P2 do not affect the labels. Refer to The Absolute Direction Instruction, DI, and The Absolute Size Instruction, SI.

Two examples of mirrored labels are shown on the next page. In the first example, the DI parameters 3,2 place the directional line in the first quadrant. The negative width parameter of the SI instruction mirrors the label in the right-to-left direction. In the second example,

the DI parameters 3, -2 place the directional line in the fourth quadrant. The negative height parameter of the SI instruction mirrors the label top-to-bottom.

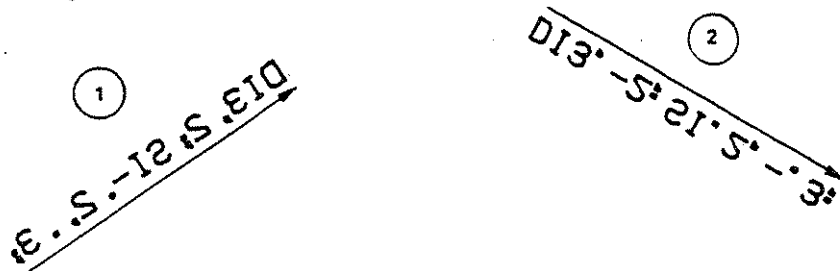

Use of DR and SI

When DR and SI instructions are used together, the label size is determined by the SI instruction and does not change with changes in the settings of P1 and P2. However, changes in the settings of P1 and P2 will affect the label direction. The algebraic differences $(P2_x - P1_x)$ and $(P2_y - P1_y)$ are multiplied by the run and rise parameters of the DR instruction. The resulting parameters, when applied to the standard coordinate system, determine the label baseline. Mirroring about this baseline is determined by the signs of the SI parameters.

In illustration 3, P1 and P2 are at their default settings so the algebraic differences $(P2_x - P1_x)$ and $(P2_y - P1_y)$ are both positive. The DR parameters 3, -2 are used as is and establish the directional line in the fourth quadrant. The negative SI height parameter mirrors the label from top to bottom.

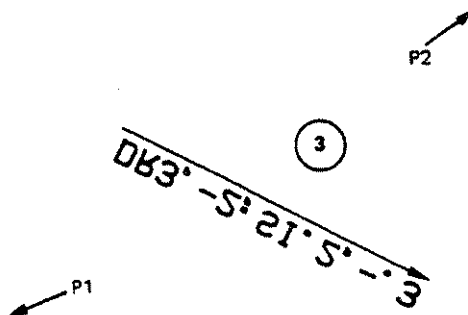

In illustrations 4 and 5, P1 is moved to the lower-right corner and P2 becomes the upper-left corner. Now $(P2_x - P1_x)$ is negative. The DR instruction as given is DR 3, -2; the run parameter of the DR instruction is multiplied by -1 and the effective DR instruction becomes DR -3, -2 placing the directional line in the third quadrant. The negative SI

height parameter mirrors the label from top to bottom. In illustration 5, both SI parameters are negative and the label is mirrored in both directions, making it appear upright.

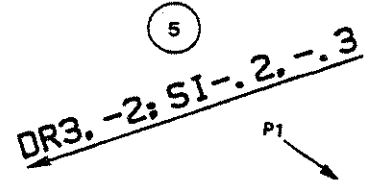
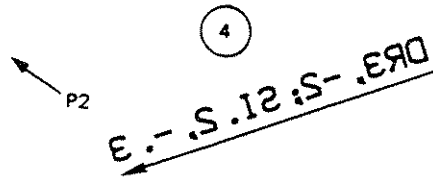

Use of DI and SR

When the DI instruction is used with SR, only the DI instruction affects the directional baseline of labels; changes in the relative positions of P1 and P2 do not affect the baseline. Mirroring about this baseline will occur when either a negative SR width or height parameter with a positive difference ($P2_x - P1_x$) or ($P2_y - P1_y$) or a positive SR parameter and a negative difference are present. If respective parameters and differences are both positive or both negative, no mirroring will occur.

Label direction is horizontal for all illustrations in this section. The first three illustrations are drawn with P1 and P2 at their power-on settings. In example 6, the SR; instruction is the same as SR.75, 1.5. Since the parameters are positive, there is no mirroring. In example 7, the negative width parameter causes mirroring right-to-left. In example 8, the negative height parameter causes mirroring top-to-bottom.

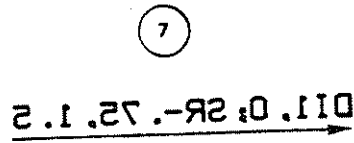
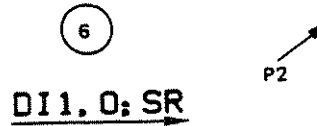

In the next three illustrations, P1 and P2 have been changed so P1 is lower right and P2 is upper left. Hence $(P2_x - P1_x)$ is negative and anything with a positive SR width parameter is mirrored right-to-left, e.g., illustrations 9 and 11. The effect of the negative width parameter in illustration 10 is cancelled by the negative difference $(P2_x - P1_x)$.

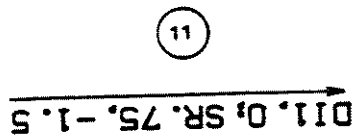
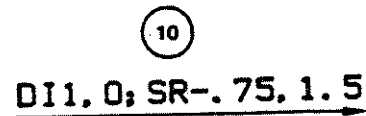
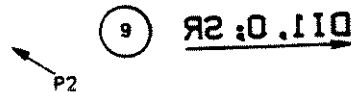

In the next illustrations, P1 and P2 have both been flipped so P1 is upper right and P2 is lower left. Now any positive parameter causes mirroring and any negative parameter cancels mirroring. This can be seen in examples 12, 13, and 14.

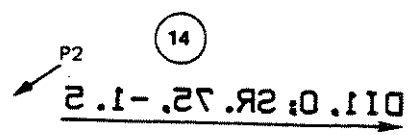
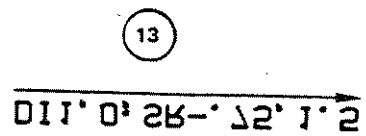
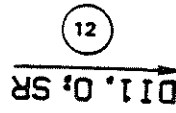

Use of DR and SR

When the DR and SR instructions are used together, interactions are most complex. Using only standard settings of P1 and P2, where P1 is the lower-left corner and P2 is the upper-right corner, will make it easier for you to establish the direction and mirroring of labels you desire. DR parameters interact with the algebraic differences $(P2_x - P1_x)$ and $(P2_y - P1_y)$ to establish label direction, and SR parameters interact with these differences to create mirroring. Signs of both parameters and differences are important. A negative sign in either the parameter or the distance will affect both DR and SR instructions. Having both parameter and distance either positive or negative will cause standard direction or no mirroring.

The following examples show the most complex cases, with P1 and P2 in nonstandard locations. Label 15 is drawn with the instructions DR 1, 1; SR in effect, P1 in the lower-right corner and P2 in the upper-left corner. The label baseline is in the second quadrant, not the first, because $(P2_x - P1_x)$ is negative and the DR run parameter is positive. Likewise, the label is mirrored left-to-right because that distance is negative while the parameter is positive. In labels 16 and 17, the label direction baseline is in the third quadrant because both $(P2_x - P1_x)$ and $(P2_y - P1_y)$ are negative. Label 16 is mirrored in both directions. (Rotate the manual so the arrow points to +45 degrees to see this more clearly.) In label 17, the label is not mirrored because both parameters and distances are negative. (Again, this may be easier to see if you rotate the manual.)

P2

15

DR1. 1; SR. 2.5

P1

16

DR1. 1; SR. 1

P1

17

DR1. 1; SR. 1.75; -1.5

P2

5-28 LABELING

Advanced Programming Tips

When drawing labels, you often wish to position them precisely in relation to a specific point. Unless positioned differently by the programmer, labels are written beginning at the current pen position which marks the baseline of the label.

The following BASIC program illustrates various ways to center labels. The program uses the BASIC function LEN to find the length of the string. This length is used to determine horizontal adjustments, i.e., how many character-space widths the pen must be moved to achieve the desired positioning. Vertical moves are in terms of character-space heights. Since an uppercase letter is half the height of a character space, a vertical movement of one-quarter character space down will center uppercase letters on the point; notice the parameter is negative. A parameter of -0.5 will cause the top of uppercase letters to be level with the point.

Symbol mode plotting, with an * as the symbol, has been used here to show pen position at the start of the label instruction. The character plot instruction which positions the label is shown above each label.

```
10 OPEN "COM1:9600,N,8,1,RS,CS65535,DS,CD" AS #1
20 DIM A$(40),B$(40),C$(40)
30 A$ = "THIS LABEL IS RIGHT JUSTIFIED"
40 PRINT #1, "IN;SP1;SM*;PA6000,5500;"
50 PRINT #1, "CP";-LEN(A$);"0;LB";A$+CHR$(3)
60 B$ = "THIS LABEL IS CENTERED BELOW THE POINT"
70 PRINT #1, "PA4500,5000;"
80 PRINT #1, "CP";-LEN(B$)/2;"-.5;LB";B$+CHR$(3)
90 C$ = "VERTICALLY CENTERED LABEL"
100 PRINT #1, "PA2750,4500;"
110 PRINT #1, "CP0,-.25;LB";C$+CHR$(3)
120 END
```

```
"CP";-LEN(A$);"0;"
```

THIS LABEL IS RIGHT JUSTIFIED*

```
"CP";-LEN(B$)/2;"-.5;"
```

THIS LABEL IS CENTERED* BELOW THE POINT

```
*CP0,-.25;"
```

*VERTICALLY CENTERED LABEL

Chapter 6

Digitizing

What You'll Learn in This Chapter

The plotter can be used as a digitizer as well as a plotter. Digitizing consists of moving the pen or digitizing sight to a point on the plotting surface, entering the point, and sending the coordinates of that point to the computer. This chapter describes the three instructions used in digitizing, and contains a discussion of the steps required by a computer program for digitizing; sample programs are also included. Included in the discussion are three different methods of assuring that a point has been entered. The method you will use will depend on your application and your interface (HP-IB or RS-232-C).

HP-GL Instructions Covered

- DP The Digitize Point Instruction
- DC The Digitize Clear Instruction
- OD The Output Digitized Point and Pen Status Instruction

Terms You Should Understand

Digitizing — converting information, in this case pen position and up/down status, to digital information so that it can be understood by the computer.

Output Terminator — the character or characters sent by the plotter at the end of the response to an output instruction. It is interface-dependent.

Preparing Your Plotter for Use as a Digitizer

A plotter with an HP-IB interface must be set to an address less than 31 because the plotter cannot send the coordinates of a digitized point to the computer when it is in listen-only mode.

Use of a digitizing sight, available as an accessory with the 7475, is recommended. The sight should be loaded manually into the pen holder itself. Slip the digitizing sight gently into the pen holder just as you would slip in a pen.

CAUTION

The sight should not be stored in a pen stall; do not store using front panel buttons or an SP command. Remove the sight from the pen holder before raising the **PAPER LOAD** lever since the sight would be stored automatically when the lever is raised.

To remove the sight from the pen holder, slip the sight out of the pen holder.

The sight is used in the pen down position.



Loading the Sight

The Digitize Point Instruction, DP

DESCRIPTION The digitize point instruction, DP, provides the means to digitize points on the plotter.

USES This instruction can be used to input data for a graphics program or obtain the coordinates of a point or points on the plot.

SYNTAX *DP* terminator

EXPLANATION No parameters are used.

When the *DP* instruction is received, automatic pen lift is suppressed, the current front-panel paper-size light blinks, and the plotter is ready to have a digitized point entered by pressing **ENTER** on the front panel.

When **ENTER** is pressed, the X- and Y-coordinates of that point and pen up/down status are stored for retrieval by the *OD* instruction. Pressing **ENTER** sets bit position 2 of the status byte, indicating a digitized point is available for output.

After **ENTER** has been pressed, automatic pen lift is reactivated, and the paper-size light stops blinking.

The Digitize Clear Instruction, *DC*

DESCRIPTION The digitize clear instruction, *DC*, provides a means to terminate digitize mode.

USES This instruction can be used to terminate digitize mode without entering a point. If you are using an interrupt routine in a digitizing program to branch to some other plotting function, you could use *DC* to clear digitize mode immediately after branching.

SYNTAX *DC* terminator

EXPLANATION No parameters are used.

When the *DC* instruction is received, digitize mode is terminated, and the paper-size light stops blinking. Automatic pen lift is reactivated.

The Output Digitized Point and Pen Status Instruction, *OD*

DESCRIPTION The output digitized point and pen status instruction, *OD*, is used to output the X- and Y-coordinates and pen up/down status associated with the last digitized point.

USES This instruction is used after *DP* and **ENTER** in all digitizing applications to return the coordinates of the digitized point to the computer.

SYNTAX *OD* terminator

EXPLANATION No parameters are used.

The timing of output depends on the plotter's interface (HP-IB or RS-232-C). Refer to A Brief Word about Plotter Output in Chapter 7 for more information.

The pen position and status are output to the computer as integers in ASCII in the form:

X,Y,P TERM

where X is the X-coordinate of the digitized point in plotter units,
Y is the Y-coordinate of the digitized point in plotter units,
P is the pen status when the point was entered (0 = pen up, 1 = pen down), and
TERM is the output terminator for your system (refer to Chapter 7).

The ranges of the X- and Y-coordinates are the hard-clip limits of the plotter as determined by the setting of the paper switches.

Upon receipt of the OD instruction by the plotter, bit position 2 of the output status byte is cleared.

Digitizing with the 7475

When using the plotter as a digitizer, it is important to ascertain that a point has been entered before an attempt is made to retrieve that point using the OD instruction. There are three methods for doing this.

Manual Method

The first method, which might be called the manual method, is easiest to understand. It is not efficient in applications where many points will be entered, or in an RS-232-C environment where the mainframe is not adjacent to the plotter or where human intervention in program execution is not possible. The steps in this method are as follows:

1. In a program, send a DP instruction to the plotter. Follow the DP instruction immediately with a statement that will cause the program to display or print a message prompting you to enter a point. Follow the prompt with a statement that will cause the program to pause until instructed to continue. The BASIC statement PAUSE will accomplish this.
2. Move the digitizing sight (pen) to the point to be entered, using front-panel buttons. Final positioning should be done with the sight (pen) down.
3. Press ENTER on the plotter's front panel. Now resume running of the program. This is done on HP desktop computers by pressing the key marked CONTINUE or CONT.

4. The program step following the pause will now be executed. The next steps of the program, in order, should be an OD instruction to the plotter, a read statement by the computer to read the X- and Y-coordinates and the pen status, a statement to remove the prompt (requesting you to enter a point) from the screen, and then steps to process the digitized data in the appropriate manner.

Using this method, there is no need to monitor the status byte because the program does not proceed to the OD instruction until the user enters a point and causes the program to resume.

A simpler procedure, using OA or OC instead of OD, can also be used. It omits the DP in step 1 and pressing ENTER in step 3. Using the shorter procedure with OC makes it possible to obtain coordinate values in user units. Refer to Chapter 7.

A short program to digitize a single point and display the coordinates and pen status is given below.

```
10 OPEN "COM1:9600,N,8,1,RS,CS65535,DS,CD" AS #1
20 PRINT #1, "DP:"
30 PRINT "Enter a point, then press RETURN"
40 INPUT NS
50 PRINT #1, "OD:"
60 INPUT #1, X,Y,P
70 PRINT X, Y, P
80 END
```

Monitoring the Status Byte

The second method monitors bit position 2 (the third least significant bit) of the plotter's status byte, which is set when a digitized point is available. Refer to the Output Status Instruction, OS, in Chapter 7 for more information.

There are a variety of ways to monitor bit position 2, depending on the instructions available in the computer you are using. The status byte can be operated on arithmetically to check for the availability of a digitized point. Executing successive divisions of a number by a power of two and checking the answer for an odd or even integer is a common way of monitoring bits without converting the number to binary form. The following example uses this method.

Example — Digitizing by Monitoring the Status Byte

The following sequence of BASIC instructions will check the proper bit of the status byte. In line 50, the INPUT# statement reads the status byte into a variable called Status. (INT is a function that returns the integer portion of a number.)

```

10 OPEN "COM1:9600,N,8,1,RS,CS65535,DS,CD" AS #1
20 PRINT #1, "DP:"
30 PRINT "Enter a point by pressing ENTER"
40 PRINT #1, "OS:"
50 INPUT #1, STATUS
60 STATUS = INT(STATUS/4)
70 IF STATUS = INT(STATUS/2)*2 THEN 40
80 PRINT #1, "OD:"
90 INPUT #1, X,Y,P
100 PRINT X,Y,P
110 END

```

Program Explanation

| | |
|-----|---|
| 10 | configuration statement |
| 20 | prepares plotter to accept a digitized point |
| 30 | prompts you to enter a point on the plotter and press ENTER on the plotter. |
| 40 | sends the output status instruction |
| 50 | reads the status |
| 60 | shifts bits right by two positions |
| 70 | if a point hasn't been obtained, reads status again |
| 80 | outputs the digitized point |
| 90 | reads X, Y coordinates and pen status (up/down) |
| 100 | displays X, Y coordinates and pen status |

Example — Digitizing Many Points

In many applications, a large number of points need to be digitized. When the computer is used to monitor bit position 2, the data points may or may not be processed immediately. Generally, you need to allocate space for the total number of points to be digitized. Then, you can establish a loop to process the total number of points, calling a subroutine each time to check that a point has been entered.

A complete BASIC program follows. When prompted to enter a point, use the cursor keys to move the digitizing sight to the desired position. Now press the **ENTER** button on the plotter. Continue for all 25 points. Their coordinates will be displayed on the computer's screen after they have all been entered.

```

10 OPEN "COM1:9600,N,8,1,RS,CS65535,DS,CD" AS #1
20 DIM X(25),Y(25),P(25)
30 FOR C = 1 TO 25
40   PRINT #1,"DP;"
50   PRINT "ENTER POINT "C
60   GOSUB 140
70   PRINT #1,"OD;"
80   INPUT #1,X(C),Y(C),P(C)
90 NEXT C
100 FOR C = 1 TO 25
110   PRINT X(C),Y(C),P(C)
120 NEXT C
130 END
140 REM Check bit 2 for available digitized point
150 PRINT #1,"OS;"
160 INPUT #1,STATUS
170 STATUS = INT(STATUS/4)
180 IF STATUS = INT(STATUS/2)*2 THEN 150
190 RETURN

```

HP-IB Interrupts and Polling

A third method can be used by advanced programmers thoroughly familiar with the HP-IB interface, polling techniques, and interrupts. It should only be used when the computer can perform useful tasks while waiting for the digitized point to be entered. This method involves setting a value of 4 in the S-mask of the IM instruction, e.g., IM 223, 4, 0; to cause the plotter to generate an RQS (service request) when a digitized point is available. With an interrupt routine enabled for service requests, the computer can send a DP instruction to initiate digitizing, and then proceed with some other task until the digitized point is entered. When the point is available, the computer is interrupted by the RQS, and program execution branches to the routine to process the digitized data. This routine could simply send an OD instruction and read the digitized point, or it could perform bit checking of the plotter status byte if multiple S-mask values have been specified to generate the RQS. The status byte can be obtained by serial polling or simply by sending an OS instruction. Because interrupts and polling are highly machine-dependent and beyond the scope of this manual, no examples are given.

Chapter 7

Obtaining Information from the Plotter

What You'll Learn in This Chapter

Up to this time we have mainly been concerned with sending information or data to the plotter. Sometimes, however, we want to know something about the plotter, its current pen position, its status, whether an error has occurred, or what capabilities the plotter has. In this chapter you will learn about most of the plotter's output instructions. The output P1 and P2, the output window, and the output hard-clip limits instructions are discussed in Chapter 2 and the output digitized point instruction is discussed in Chapter 6. All other output instructions are discussed in this chapter. The timing of output depends on your interface (HP-IB or RS-232-C). Before using the output instructions, you should have read the notes below and the appropriate interfacing chapter in this manual.

HP-GL Instructions Covered

- OA The Output Actual Position and Pen Status Instruction
- OC The Output Commanded Position and Pen Status Instruction
- OE The Output Error Instruction
- OF The Output Factors Instruction
- OI The Output Identification Instruction
- OO The Output Options Instruction
- OS The Output Status Instruction

Terms You Should Understand

Output Terminator — denoted in this manual as TERM — the ASCII character or characters sent by the plotter at the end of a plotter response to an output instruction. With an HP-IB interface, the two characters, carriage return and line feed, are the output terminator. With an RS-232-C interface, the output terminator is a carriage return, unless modified by an ESC . M command.

A Brief Word about Plotter Output

There are slight differences in the timing of output when the plotter is used with the HP-IB or RS-232-C interfaces. Read the paragraph below which pertains to your system.

Notes for an HP-IB User

When the 7475 has an HP-IB interface, the terminator for an output statement, denoted TERM, is a carriage return followed by a line feed.

The output instructions in this chapter should not be used when the plotter is in listen-only mode since the plotter in listen-only mode cannot output anything. Output instructions will be ignored by the plotter so the computer will get no response to its read statement, and, typically, the program will halt.

A plotter with an HP-IB interface will respond only when the computer sends a read instruction (the plotter is instructed to talk). Therefore, a read statement should directly follow any output instruction. When a second output instruction is received before data from the first instruction has been read, the new data overwrites the old data and the old data is lost. Refer to Chapter 9 for more information.

Notes for an RS-232-C User

With an RS-232-C interface, the 7475's terminator for an output statement, denoted TERM, is a carriage return, unless the terminator is modified by an ESC . M instruction. As soon as an output instruction has been parsed by the plotter, output occurs according to the handshake protocol established by the ESC . M and ESC . N instructions. Use of turnaround delays, intercharacter delays, and an output initiator should be specified as necessary to assure that output will not be lost because the computer is not prepared to receive it. The information necessary to assure this should be contained in the documentation for your computer. Refer to Chapter 10 of this manual for more information.

The Output Actual Position and Pen Status Instruction, OA

DESCRIPTION The output actual position and pen status instruction, OA, is used to output the X- and Y-coordinates and pen status (up or down) associated with the actual pen position.

USES This instruction can be used to determine the pen's current position in plotter units. You might use that information to position a label or figure, or determine the parameters of some desired window.

SYNTAX OA terminator

EXPLANATION Output is always in plotter units.

No parameters are used.

The pen position and status are output to the computer as integers in ASCII in the form:

X,Y,P TERM

where X is always the X-coordinate in plotter units,
Y is always the Y-coordinate in plotter units,
P is the pen status (0 = pen up, 1 = pen down), and
TERM is the output terminator for the interface installed.

The ranges of the X- and Y-coordinates are the hard-clip limits determined by the setting of the paper switches.

Hard-clip Limits

| Paper Size | Hard-clip Limits | |
|------------|-------------------------|-------------------------|
| | X-axis | Y-axis |
| A | $0 \leq X \leq 10\ 365$ | $0 \leq Y \leq 7962$ |
| B | $0 \leq X \leq 16\ 640$ | $0 \leq Y \leq 10\ 365$ |
| A4 | $0 \leq X \leq 11\ 040$ | $0 \leq Y \leq 7721$ |
| A3 | $0 \leq X \leq 16\ 158$ | $0 \leq Y \leq 11\ 040$ |

No positive sign is output.

The Output Commanded Position and Pen Status Instruction, OC

DESCRIPTION The output commanded position and pen status instruction, OC, is used to output the X- and Y-coordinates and pen status (up or down) associated with the last valid pen position instruction.

USES This instruction can be used to determine the pen's last valid commanded position in plotter units or user units depending on whether scaling is off or on. You might use that information to position a label or figure, or determine the parameters of an instruction which moved the pen to the limits of some window.

SYNTAX OC terminator

EXPLANATION Output is in decimal format, in user units when scaling is in effect, and in plotter units when scaling is off.

No parameters are used.

The pen position and status are output to the computer as decimal numbers in ASCII in the form:

X,Y,P TERM

where X is always the X-coordinate in plotter units or user units,
Y is always the Y-coordinate in plotter units or user units,
P is the pen status (0 = pen up, 1 = pen down), and
TERM is the output terminator for the interface installed.

When scaling is off, X- and Y-coordinates are in plotter units. When scaling is on, X- and Y-coordinates are in user units. Ranges of the X-and Y-coordinates are -32 768 to 32 767 whether scaling is on or off.

When the commanded pen position is such that its user unit value would be less than -32 768 or greater than 32 767, the output may not represent the true pen position. If the plotter were scaled with the given instructions as shown in the following illustration, all points in the lightly shaded areas will have one coordinate as 32 767, the largest number the plotter can output. All points in the darker shaded area will have both coordinates as 32 767. One way to access this area is with the AA instruction.

Instructions executed:

"IP 0,0,6000,3500; SC 0,32767,0,32767;"

OUTPUT:
X-PARAMETER, 32 767 , PEN STATUS

OUTPUT:
32 767 , 32 767 , PEN STATUS

P2 6000 , 3500

OUTPUT:
32 767 , Y-PARAMETER , PEN STATUS

P1 0 , 0

The Output Error Instruction, OE

DESCRIPTION The output error instruction, OE, is used to output the decimal equivalent of the first HP-GL error (if any).

USES This instruction can be used to determine the type of the first error. It is useful when debugging programs or to determine if all data or instructions were accepted by the plotter.

SYNTAX OE terminator

EXPLANATION No parameters are used.

When an OE instruction is received, the plotter converts the first HP-GL error to a positive integer in ASCII, which is output in the form:

error number TERM

The error number is defined as follows:

| Error Number | Meaning |
|--------------|---|
| 0 | No error |
| 1 | Instruction not recognized |
| 2 | Wrong number of parameters |
| 3 | Out-of-range parameters |
| 4 | Not used |
| 5 | Unknown character set |
| 6 | Position overflow |
| 7 | Not used |
| 8 | Vector received while pinch wheels raised |

TERM is the output terminator for the interface installed.

In an HP-IB system after the carriage return has been sent, and in an RS-232-C system after the output is complete, bit position 5 of the status byte is cleared (if set), and the **ERROR LED** (if lit) is turned off (unless there is an RS-232-C error which has not been cleared by an ESC.E instruction).

You should note that anytime the plotter receives an unpaired alphabetic character, error 1 will be set. Thus, an alphabetic parameter or three alphabetic characters in a row will generate error 1. When you encounter error 1, look for a misplaced alphabetic character.

Once your plotting programs are debugged, you may want to remove most output error instructions from your program to reduce your computer's I/O operations and maximize plotting speed.

The Output Factors Instruction, OF

DESCRIPTION The output factors instruction, OF, is used to output the number of plotter units per millimetre in each axis.

USES This instruction enables the plotter to be used with software which must know the size of a plotter unit.

SYNTAX OF terminator

EXPLANATION No parameters are used.

The plotter will always output the following:

40 , 40 TERM

These factors indicate that there are approximately 40.2 plotter units per millimetre in the X-axis and in the Y-axis (0.025 mm/plotter unit). TERM is the output terminator for the interface installed.

The Output Identification Instruction, OI

DESCRIPTION The output identification instruction, OI, is used to output a plotter identifier.

USES This instruction is especially useful in a remote operating environment to determine which model plotter is on-line.

SYNTAX OI terminator

EXPLANATION No parameters are used.

The plotter will always output the following character string:

7475A TERM

TERM is the output terminator for the interface installed.

The Output Options Instruction, OO

DESCRIPTION The output options instruction, OO, is used to output eight option parameters.

USES This instruction is especially useful in a remote operating environment to determine which options are available in the plotter which is on-line.

SYNTAX OO terminator

EXPLANATION No parameters are used.

The plotter will always output the appropriate combination of eight integers in ASCII, separated by commas. The options included in the plotter are indicated by a 1 as defined below.

0, 1, 0, 0, 1, 0, 0, 0 TERM

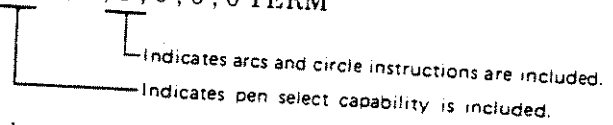

TERM is the output terminator for the interface installed.

The Output Status Instruction, OS

DESCRIPTION The output status instruction, OS, is used to output the decimal equivalent of the status byte.

USES This instruction is useful in debugging operations and in digitizing applications.

SYNTAX OS terminator

EXPLANATION No parameters are used.

Upon receipt of the OS instruction, the internal eight-bit status byte is converted to an integer between 0 and 255. Output is in ASCII in the form:

status TERM

The status bits are defined as follows:

| Bit Value | Bit Position | Meaning |
|-----------|--------------|---|
| 1 | 0 | Pen down. |
| 2 | 1 | P1 or P2 changed; cleared by reading output of OP in HP-IB system or by actual output of P1,P2 in RS-232-C system, or by IN instruction. |
| 4 | 2 | Digitized point available; cleared by reading digitized value in HP-IB system or by output of point in RS-232-C system, or by IN instruction. |
| 8 | 3 | Initialized; cleared by reading OS output in HP-IB system or by output of the status byte in RS-232-C system. |
| 16 | 4 | Ready for data; pinch wheels down. |
| 32 | 5 | Error; cleared by reading OE output in HP-IB system or by output of the error in RS-232-C system, or by IN instruction. |
| 64 | 6 | Require service message set (always 0 for OS; 0 or 1 for HP-IB serial poll). |
| 128 | 7 | Not used |

Upon power up, the status is decimal 24, the sum of 8 (initialized) and 16 (ready for data). Upon output of the status byte after an OS instruction, bit position 3 is cleared.

Summary of Output Response Types

The following table shows the number and type of items in the response to each HP-GL output instruction. The table includes output instructions explained in Chapters 2 and 6 as well as in this chapter. This table will be helpful when programming in languages such as FORTRAN which require you to specify the type of and number of digits in a variable.

| Instruction | Number of Parameters Returned* | Type and Range |
|-------------|--------------------------------|--|
| OA | 3 | integers, all ≤ 5 digits |
| OC | 3 | maximum 5 digits in integer portion, maximum 4 digits in fractional portion (sign and decimal point optional) |
| OD | 3 | integers, all ≤ 5 digits |
| OE | 1 | integer, 1 digit |
| OF | 2 | integers, 2 digits each |
| OI | 1 | 5-character string |
| OO | 8 | integers, 1 digit each |
| OP | 4 | integers, all ≤ 5 digits |
| OS | 1 | integer, ≤ 3 digits |
| OW | 4 | integers, all ≤ 5 digits |

*In addition to these parameters, the output terminator TERM is always sent at the end of output, and commas are sent to separate parameters.

Chapter 8

Putting the Instructions to Work

What You'll Learn in This Chapter

In this chapter you'll learn how to put instructions together to develop a plot. The following examples are designed to show you how to integrate many instructions into a complete program, how data might be handled, and how subroutines are used to program a task that is common to many plots and could be used in several programs.

Remember that these programs are written in Microsoft® BASIC. They use techniques such as FOR . . . NEXT loops and subroutines to read data and draw plots. If necessary, check your computer documentation for the correct methods of implementing these techniques.

The first program draws a line chart, one of the most common types of plots. You can use line charts to plot almost any kind of data — sales data, factory output, sales volume, data from laboratory experiments, population trends, etc. The concepts of plotting and labeling demonstrated here can be used in almost any application.

The second program draws a stacked bar chart; the third program draws a pie chart. The sales data are differentiated in bars or wedges by solid fill, cross-hatching and parallel hatching. The programs demonstrate how to define fill types and how to fill and outline rectangles and wedges.

The first program is explained in detail, and is organized to show you how to develop a program. The second two programs are explained more briefly, because the concepts of developing these programs are similar to developing the line chart.

NOTE: Some computers use an Xon-Xoff handshake to prevent buffer overflow and data loss. ■

To set up an Xon-Xoff handshake, insert the following lines in your program after the configuration statement. (For more information, refer to the ESC . I and ESC . N instructions in Chapter 9.)

```
PRINT #1, CHR$(27);".I 81;:17:"  
PRINT #1, CHR$(27);".N;19:"
```

Line Chart

For this line chart, you will scale, draw, and label an X- and Y-axis and plot 1985 sales by region. The following paragraphs develop segments of the program in a logical sequence. The complete plot and program are shown later in the section titled Program Listing.

Setup and Scaling

For emphasis and readability, you should draw the title and important data with wide pens. Narrow pens are usually sufficient for axes and labels. For this line chart, the suggested pen order for the carousel is:

| | |
|----------------|----------------|
| 1 = black, P.3 | 5 = green, P.3 |
| 2 = black, P.7 | 6 = aqua, P.3 |
| 3 = red, P.3 | 7 = unused |
| 4 = blue, P.3 | 8 = unused |

Begin your program with the appropriate configuration statement for your computer. Then, using the IN or DF instruction, set the plotter to known conditions and cancel any parameters that may have been set in a previous program. IN is used here to be sure *all* conditions (such as P1/P2 settings) are set to a default state.

Select a pen (SP 1;) and establish scaling points for this plot. The parameters of the IP instruction determine the location of the scaling points, P1 and P2. The location of these points provides a convenient area for the scale, which is assigned in the scaling statement SC 1,12,0,150;. Since this chart shows one year's sales by month, the X-axis (commonly representing time) is scaled from 1 to 12. The Y-axis is scaled in thousands from 0 to 150 so that all sales data will fall inside this range. Labels and titles will be placed outside this area.

You will either need to know the range of your data or be willing to try some plots with different scales to determine what your scale statement should be. Thousands or millions of dollars are common scales.

Once the scale is established, draw a frame for the data area. Here PU 1,0; moves the pen to the first point with the pen up. The pen is then lowered and connects the four corners.

The first three program lines to accomplish the above are:

```
20 PRINT #1, "IN;SP1;IP1250,750,9250,6250;"  
30 PRINT #1, "SC1,12,0,150;"  
40 PRINT #1, "PU1,0;PD12,0,12,150,1,150,1,0;PU;"
```

The Axes and Their Labels

You are now ready to draw and label the axes. The absolute label size instruction, SI 0.2, 0.3;, creates characters slightly larger than the default character size. The tick length is established by the instruction TL 1.5,0;. The resulting ticks will be 1.5% of the horizontal or vertical distances between scaling points.

This program uses a FOR...NEXT loop to draw the axes. For the X-axis, let X range from 1 to 12 to represent 12 months of data. The loop does four things: moves to the integer location on the X-axis, draws a tick mark, establishes the label origin, and draws the label. Note that the X-parameter of the plotting instruction is a variable. If you do not know how to send a variable to the plotter, consult your computer's documentation and Plotting with Variables in Chapter 3. Since the XT instruction draws a tick whether the current pen status is up or down, be sure the pen is up to avoid unwanted lines between the ticks, labels, and axis.

Place the labels in a DATA statement in order to use the looping technique for labeling axes. (At some point, you might want to access data for the latest 12 months. If your data were stored with a data code, you could use a similar technique to read the labels and data from a file and properly label your chart for the data you were then plotting.) Then access the labels with a string variable in the LB instruction. Refer to Labeling with Variables in Chapter 5 for hints on sending variables in labels.

To position the labels, the program uses the CP instruction to center the label under the tick. By moving one-third character space back and one line down, the single character label is centered under the tick with enough space to be easily read. Finally, the axis title, Calendar Month, is centered and drawn under the axis.

The following lines contain the statements that perform the functions just described.

```
50 PRINT #1, "SI.2,.3;TL1.5,0;"
60 FOR X = 1 TO 12
70 PRINT #1, "PA";X;",";0;XT;"
80 READ A$
90 PRINT #1, "CP-.33,-1;LB"+A$+CHR$(3)
100 NEXT X
110 PRINT #1, "PA6.5,0;CP-7,-2.5;"
120 PRINT #1, "LBCalendar Month"+CHR$(3)

500 DATA "J","F","M","A","M","J"
510 DATA "J","A","S","O","N","D"
```

The Y-axis is created in a similar manner, except that the program uses the loop's index for the label value and two different CP instructions for labels of three digits and labels of less than three digits.

The lines which draw the Y-axis and label it follow.

```
130 FOR Y=0 TO 150 STEP 25
140   PRINT #1, "PA1,";Y;"YT;"
150   IF Y<100 THEN PRINT #1, "CP-3,-.25;"
160   IF Y>99 THEN PRINT #1, "CP-4,-.25;"
170   PRINT #1, "LB";Y;CHR$(3)
180 NEXT Y
190 PRINT #1, "PA1,150;CP-3.5,2;"
200 PRINT #1, "LBSales $"+CHR$(3)+"CP-9,-1;"
210 PRINT #1, "LB(Thousands)"+CHR$(3)
```

Change to a wide pen to plot the title. Next, move to the top center of the chart, increase the character size, and label the chart title.

The program lines that title the chart are:

```
220 PRINT #1, "SP2;PA6,150;SI.4,.6;CP-9.5,2;"
230 PRINT #1, "LB1985 Sales by Region"+CHR$(3)
```

Here's what the chart looks like so far.

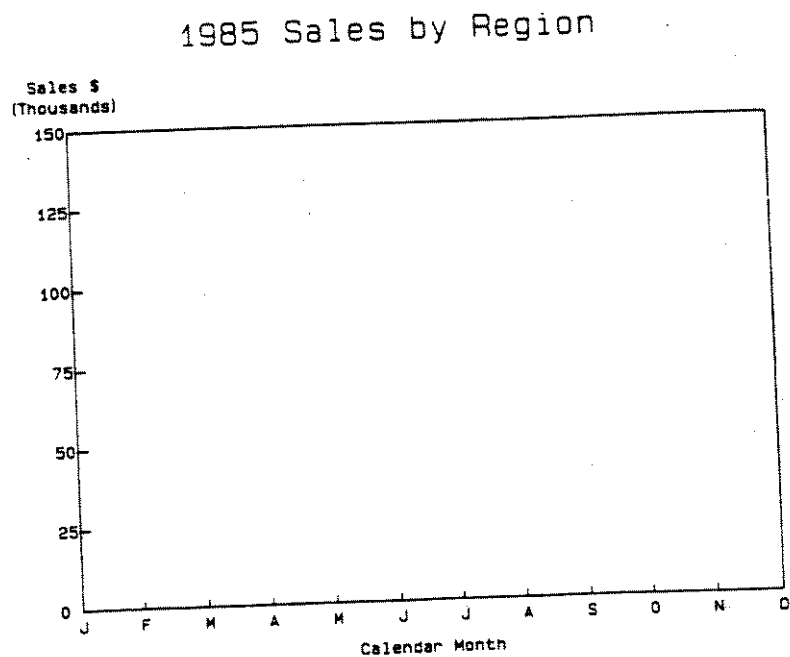

Plotting the Data

You are now ready to draw lines. The first data line is drawn with parameters included when the program was written. Therefore, if the data changes, it will be necessary to change the plot instructions in the program.

The first line is drawn with pen 6 using the default solid line type. After drawing the line, the pen moves (up) to an area appropriate for labeling. After the character size is changed to match that used to label the axes, the plotter labels "South America." Actually, each of the data line's labels were inserted near the end of the creation process and involved trial and error to achieve satisfactory placement. Each label is drawn after each line of data is plotted.

The program lines which plot the lowest line and the corresponding label are:

```
240 PRINT #1, "SP6;LT;PA1,23;PD2,25,3,18,4,22;"
250 PRINT #1, "PD5,23,6,27,7,27,8,25,9,24,10,28;"
260 PRINT #1, "PD11,27,12,27,;PU3.6,16;"
270 PRINT #1, "SI.2,.3;LBSouth America"+CHR$(3)
```

The program plots the three remaining lines from data read at execution time using nested FOR...NEXT loops and a READ statement. You can use this technique to plot a chart that will be replotted often with new data. If the necessary file statements were added, the data could be on a tape or disk file instead of in a DATA statement as shown here.

The first FOR...NEXT loop beginning in line 280 runs 3 times, once for each of the remaining data lines. With each loop sequence, a new pen color and line type (3, 4, 5) are selected in line 290.

In line 300 the second FOR...NEXT loop begins. It runs 12 times to read each of the 12 values in the DATA statement and draw to each point. As with the first data line, the corresponding label is drawn (lines 340-360) after each line is plotted.

NOTE: Since this program uses variables as plot parameters, be sure they are sent to the plotter with a valid separator between them. Here, a comma has been inserted between variables to *ensure* that they are separated, even though many systems do not require this. Computers often send a leading and/or trailing blank space, or allow for a sign space before numeric variables. The plotter will treat a blank, comma, or a plus or minus sign as a separator between numeric parameters. Know your computer before sending variables with plot instructions. ■

The loops that draw the remaining three chart lines and the corresponding data statements follow. Although 340-360 are each printed on

two lines to fit on this page, send them to the plotter as one continuous string.

```
280 FOR I=1 TO 3
290   PRINT #1, "SP";I+2;" ;LT";I+2;" ;"
300   FOR X = 1 TO 12
310     READ Y
320     PRINT #1, "PA";X;" ;";Y;"PD;"
330   NEXT X
340   IF I=1 THEN PRINT #1, "PU4,45;LBJapan"
      +CHR$(3)
350   IF I=2 THEN PRINT #1, "PU2,64;LBEurope"
      +CHR$(3)
360   IF I=3 THEN PRINT #1, "PU2,107;LBUnited
      States"+CHR$(3)

370 NEXT I
380 PRINT #1, "SP0;"
500 DATA "J","F","M","A","M","J"
510 DATA "J","A","S","O","N","D"
520 DATA 45,50,52,53,52,51,55,56,56,58,58,60
530 DATA 55,60,63,62,59,54,50,46,47,49,53,58
540 DATA 98,100,102,105,107
550 DATA 110,125,112,115
560 DATA 125,130,122,0,0
570 END
```

Program Listing

A reduced version of the plot is shown next, followed by a complete listing of the program. Line 10 must include the proper configuration instructions necessary to establish interface conditions. You might need to make changes for your computer's BASIC. Or, you can use another programming language and send the HP-GL instructions using that language's output and looping techniques.

1985 Sales by Region

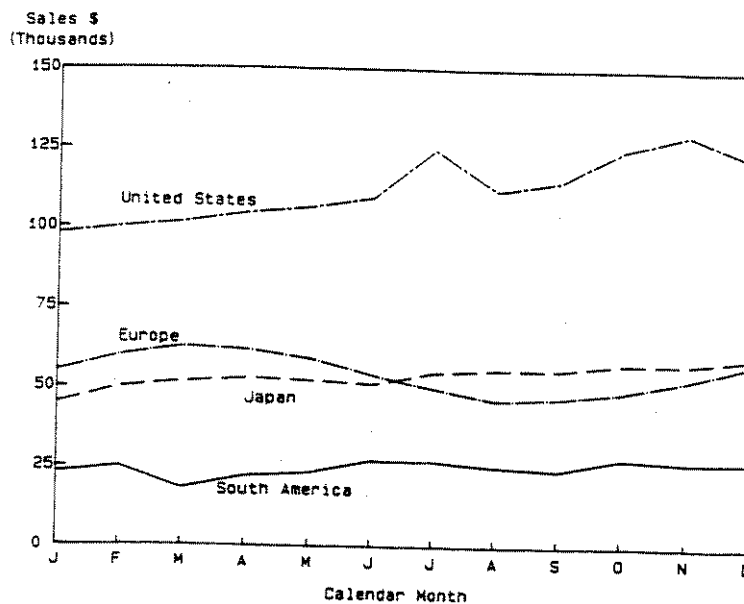

```

10 OPEN "COM1:9600,N,8,1,RS,CS65535,DS,CD" AS #1
20 PRINT #1, "IN;SP1;IP1250,750,9250,6250;"
30 PRINT #1, "SC1,12,0,150;"
40 PRINT #1, "PU1,0;PD12,0,12,150,1,150,1,0;PU;"
50 PRINT #1, "SI.2,.3;TL1.5,0;"
60 FOR X = 1 TO 12
70   PRINT #1, "PA";X;",";0;XT;"
80   READ AS$
90   PRINT #1, "CP-.33,-1;LB"+AS$+CHR$(3)
100  NEXT X
110 PRINT #1, "PA6.5,0;CP-7,-2.5;"
120 PRINT #1, "LBCalendar Month"+CHR$(3)
130 FOR Y=0 TO 150 STEP 25
140   PRINT #1, "PA1,";Y;";YT;"
150   IF Y<100 THEN PRINT #1, "CP-3,-.25;"
160   IF Y>99 THEN PRINT #1, "CP-4,-.25;"
170   PRINT #1, "LB";Y;CHR$(3)
180 NEXT Y
190 PRINT #1, "PA1,150;CP-3.5,2;"
200 PRINT #1, "LBSales $"+CHR$(3)+"CP-9,-1;"
210 PRINT #1, "LB(Thousands)"+CHR$(3)
220 PRINT #1, "SP2;PA6,150;SI.4,.6;CP-9.5,2;"
230 PRINT #1, "LB1985 Sales by Region"+CHR$(3)
240 PRINT #1, "SP6;LT;PA1,23;PD2,25,3,18,4,22;"

```



```

250 PRINT #1, "PDS,23,6,27,7,27,8,25,9,24,10,28;"
260 PRINT #1, "PD11,27,12,27,;PU3.6,16;"
270 PRINT #1, "SI.2,;3;LBSouth America"+CHR$(3)
280 FOR I=1 TO 3
290   PRINT #1, "SP";I+2;";LT";I+2;";"
300   FOR X = 1 TO 12
310     READ Y
320     PRINT #1, "PA";X;";";Y;"PD;"
330   NEXT X
340   IF I=1 THEN PRINT #1, "PU4,45;LBJapan"
        +CHR$(3)
350   IF I=2 THEN PRINT #1, "PU2,64;LBEurope"
        +CHR$(3)
360   IF I=3 THEN PRINT #1, "PU2,107;LBUnited
        States"+CHR$(3)
370 NEXT I
380 PRINT #1, "SP0;"
500 DATA "J","F","M","A","M","J"
510 DATA "J","A","S","O","N","D"
520 DATA 45,50,52,53,52,51,55,56,56,58,58,60
530 DATA 55,60,63,62,59,54,50,46,47,49,53,58
540 DATA 98,100,102,105,107
550 DATA 110,125,112,115
560 DATA 125,130,122,0,0
570 END

```

Bar Graphs and Pie Charts

Filling and Hatching

Two kinds of area fill are commonly used in bar graphs and pie charts; solid fill and hatching. Solid fill totally covers the area with color, whereas hatching fills the area with evenly spaced parallel lines. If there are lines in two directions at 90-degree angles, we call the hatching crosshatching. Sometimes a graph will have both narrow and wide hatching or crosshatching, the wide hatching having more space between the lines than the narrow.

Producing a Bar Graph

Scaling the Axes

In the following bar graph titled "Sales Volume by Region," we are plotting sales over a three-year period. For readability, the X-axis is scaled to provide a comfortable margin of space before and after each bar. The Y-axis is scaled from 0 to 500 to represent sales in thousands of dollars.

Plotting the Title

The title and axes are drawn with a wide pen (stored in stall two) for emphasis. The title is drawn first, with characters that are a little more than twice the default size. All labels are centered and offset slightly from the data area with the CP instruction.

Labeling the Axes

The bars on the X-axis are labeled without tick marks, using a narrow pen and characters that are slightly larger than default size. The Y-axis is labeled with tick marks and an extra label to show the scaling used (K\$).

Labeling the Bar Segments

The data for labeling each bar segment is input using read and data statements. This approach allows easy modification of the label data. Each segment label is centered next to the rightmost bar by computing a Y-axis position that is equal to the height of the prior segments plus one-half the height of the current segment.

Filling and Edging Each Segment

The data for each bar segment is stored in a three by three array. Each array element contains the height of a segment with respect to the Y-axis scaling. The bars are drawn from bottom to top using the FT, RA, and EA instructions to define, fill, and edge each stacked rectangular segment. Wide pens are used in stalls 3, 4, and 5 of the carousel for filling the bars.

Completion of Bar Graph

At the completion of the program, the scaling points are reset to their default location, the pen is raised and put away, and the finished plot is presented for viewing.

Sales Volume by Region

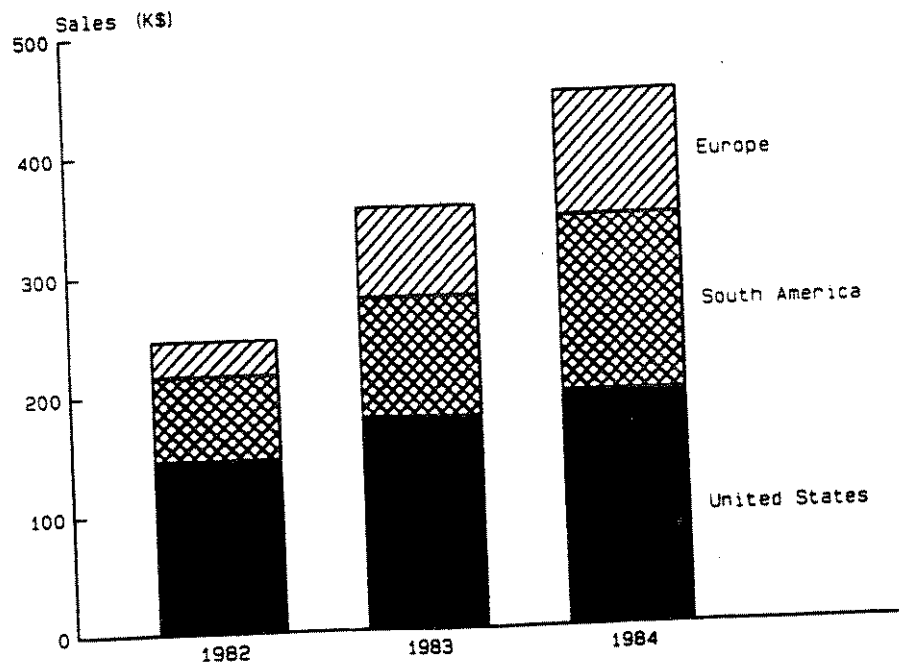

```

10  REM Generalized bar chart
20  REM
30  REM Place chart and label data in arrays
40  REM with lower bounds of 1.
50  OPTION BASE 1
60  DIM L$(80),B(3,3)
70  REM
80  DATA United States, South America, Europe
90  DATA 144,177,196,71,101,147,30,75,104
100 READ L$(1),L$(2),L$(3)
110 FOR I = 1 TO 3
120   FOR J = 1 TO 3
130     READ B(I,J)
140   NEXT J
150 NEXT I
160 REM Configuration statement
170 OPEN "COM1:9600,N,8,1,RS,CS65535,DS,CD" AS #1
180 REM Initialize plotter: set scaling points P1,P2
190 REM Scale axes
200 PRINT #1, "IN:IP1000,1000,9000,6750;"
210 PRINT #1, "SC1981,1985,0,500;"

```

(Program listing continued)

```

220 REM Label title using thick pen
230 REM then draw axes
240 PRINT #1, "PU;SP2;PA1983.3,500;SI.4,.6;CP-10,1.2;"
250 PRINT #1, "LBSales Volume by Region"+CHR$(3)
260 PRINT #1, "PU;PA1981.3,500;PD;PA1981.3,0,1985.3,0;"
270 REM Select narrow pen; reset character size.
280 REM Set tick length; then label axis.
290 PRINT #1, "PU;SP1;SI.2,.3;TL1.5,0;"
300 FOR X=1982 TO 1984
310 PRINT #1, "PA";X;"",0;CP-2.8,-1;LB";X;CHR$(3)
320 NEXT X
330 REM Add ticks and then labels to the Y-axis.
340 FOR Y= 0 TO 500 STEP 100
350 PRINT #1, "PA 1981.3,";Y;"";YT;"
360 IF Y=0 THEN PRINT #1, "CP-2.5,-.25;"
370 IF Y<>0 THEN PRINT #1, "CP-4.5,-.25;"
380 PRINT #1, "LB";Y;CHR$(3)
390 NEXT Y
400 PRINT #1, "PA1981.3,510;LBSales (K$)+"CHR$(3)
410 REM Center segment labels using prior height
420 REM plus one-half current height.
430 FOR I=1 TO 3
440 Y=0
450 FOR J=1 TO I-1
460 Y=Y+B(J,3)
470 NEXT J
480 Y=Y+B(I,3)/2
490 PRINT #1, "PA1984.4,";Y;"";
500 PRINT #1, "CP0,-.25;LB"+L$(I)+CHR$(3)
510 NEXT I
520 REM Draw and fill each bar using wide pens.
530 FOR I=1 TO 3
540 PRINT #1, "SP";I+2;"";PT.7;"
550 K=1
560 FOR X=1982 TO 1984
570 Y1=0
580 REM Compute Y-axis start point
590 REM for each bar segment.
600 FOR J=1 TO I-1
610 Y1=Y1+B(J,K)
620 NEXT J
630 REM Compute Y-axis end point
640 REM for each bar segment.
650 Y2=Y1+B(J,K)
660 K=K+1
670 REM Select fill type.

```

```

680     IF I=1 THEN PRINT #1, "FT1;"
690     IF I=2 THEN PRINT #1, "FT4,.05,45;"
700     IF I=3 THEN PRINT #1, "FT3,.05,45;"
710     REM Move to start point for segment;
720     REM then fill and outline defined bar area.
730     PRINT #1, "PA";X-.3;",";Y1;";"
740     PRINT #1, "RA";X+.3;",";Y2;";"
750     PRINT #1, "EA";X+.3;",";Y2;";"
760     NEXT X
770     NEXT I
780     REM Put pen away and end program.
790     PRINT #1, "SP0;"
800     END

```

Producing a Pie Chart

Overview

In the following pie chart titled "Sales Dollar Distribution," we are plotting the distribution of sales dollars among four groups: R&D, Administration, Marketing, and Manufacturing. Pie charts easily convey information concerning parts of a whole. Since we can easily break up the whole sales-dollar-distribution picture into four parts, the pie chart is an appropriate choice for presenting this information. For ease of understanding, pie charts ought not to be broken into less than three or more than six parts.

Inputting the Data

In the loop beginning at line 110, we input the start, mid-point, and stop angle for each segment using read and data statements. In line 155, the pie segment labels are read into arrays.

Plotting the Title

So that the pie chart will be centered, P1 and P2 are repositioned with the IP instruction and the plotting area is scaled so that 0,0 is near the center of the page. The title is centered with the CP instruction, the character size is set to 0.4 cm wide and 0.6 cm high with the SI instruction, and a wide pen is selected with the SP instruction.

Plotting the Labels

Lines 220 through 340 label each segment using the data previously stored in line 90. For readability, the labels are drawn with a narrow pen and with a character size that is smaller than the one used for the title. The labels are centered and offset from the appropriate segment with the CP instruction. We increase the distance used to position the label for segment 2, since the second segment is exploded.

Filling and Edging Each Segment

In the next loop beginning at line 360, a wide pen and a fill type are selected for each segment with the SP and FT instructions. Lines 400 and 410 adjust the center point for the exploded segment. The sweep angle for each segment is then computed (sweep angle = stop angle - start angle), and the segments are filled and outlined with the WG and EW instructions.

Completion of Pie Chart

At the completion of the program, the scaling points are reset to their default location, the pen is raised and put away, and the finished plot is presented for viewing.

Sales Dollar Distribution

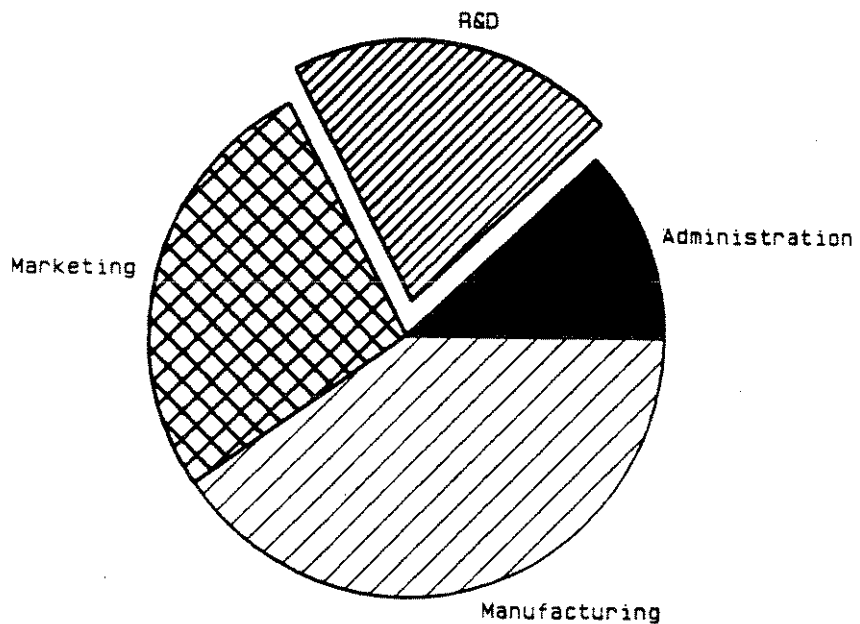

```
10 OPEN "COM1:9600,N,8,1,RS,CS65535,DS,CD" AS #1
20 REM Pie Chart
30 REM Place chart and label data in arrays
40 REM with lower bounds of 1
50 OPTION BASE 1
60 DIM WS(4),P(4,3)
70 DATA 0,21.5,43,43,30.5,118,118,166.5
```

(Program listing continued)

```

80 DATA 215,215,237,360
90 DATA Administration, R&D,Marketing,Manufacturing
100 DATA Manufacturing
110 REM Read start, mid-point, and stop angle
120 REM for each segment. Then read labels.
130 FOR I = 1 TO 4
140   FOR J = 1 TO 3
150     READ P(I,J)
160   NEXT J
170 NEXT I
180 READ W$(1),W$(2),W$(3),W$(4)
190 REM Initialize plotter; set scaling points
200 REM P1 and P2; scale the chart.
210 PRINT #1,"IN:IP2250,500,8250,7100:"
220 PRINT #1,"SC-10,10,-10,12:"
230 REM Label title using wide pen, large letters.
240 PRINT #1,"SP2;PA0,12;SI.4,.6;CP-12.34,0:"
250 PRINT #1,"LBSales Dollar Distribution"+CHR$(3)
260 REM Label each wedge using narrow pen and
270 REM small letters.
280 PRINT #1,"SP1;SI.2,.3:"
290 REM Set PI variable to convert from
300 REM radians to degrees.
310 PI=3.141593
320 FOR I = 1 TO 4
330 REM Move to center arc.
340   R = 8
350   IF I=2 THEN R=9
360   X=R*COS(P(I,2)*(PI/180))
370   Y=R*SIN(P(I,2)*(PI/180))
380   PRINT #1,"PA";X;",";Y;":"
390   REM Determine label origin ; draw label
400   L = LEN (W$(I))
410   IF I = 1 THEN PRINT #1,"CP0,-.25:"
420   IF I = 3 THEN PRINT #1,"CP";-L; "-.25:"
430   IF I = 4 THEN PRINT #1,"CP0,-.5:"
440   PRINT #1,"LB"+W$(I)+CHR$(3)
450 NEXT I
460 REM Draw and fill the wedges using pens 3-6
470 FOR I = 1 TO 4
480   PRINT #1,"SP";I+2;";PT.7:"
490   X=0
500   Y=0
510   IF I = 2 THEN X=COS(P(I,2)*(PI/180))
520   IF I = 2 THEN Y=SIN(P(I,2)*(PI/180))
530   IF I = 1 THEN PRINT #1,"FT1:"

```

```
540 IF I = 2 THEN PRINT #1,"FT3,.3,45;"
550 IF I = 3 THEN PRINT #1,"FT4,.6,45;"
560 IF I = 4 THEN PRINT #1,"FT3,.6,45;"
570 REM Compute the sweep angle
580 S=P(I,3)-P(I,1)
590 REM Fill the wedge.
600 PRINT #1,"PA";X;" ";Y;" ";
610 PRINT #1,"WG7.5,";P(I,1);" ";S;" ";
620 REM Outline the wedge.
630 PRINT #1,"EW7.5,";P(I,1);" ";S;" ";
640 NEXT I
650 REM Put pen away and end program
660 PRINT #1,"SP0;"
670 END
```

Chapter 9

HP-IB Interfacing

What You'll Learn in This Chapter

This chapter is only for 7475 owners with an HP-IB interface. HP 7475s with Option 002 have an HP-IB interface.

In this chapter you'll learn how to operate your plotter when it is connected to a computer using the Hewlett-Packard Interface Bus (HP-IB), which conforms to ANSI/IEEE 488-1978 specifications. This chapter defines the 7475's implementation of the bus. Also included are addressing the 7475, the listen-only mode, reaction to bus clear commands, serial and parallel polling, addressing the 7475 as a talker or listener, and examples of sending and receiving data using a variety of computers.

This chapter assumes you have a working knowledge of the HP-IB; however, if you wish to refresh your memory on HP-IB structure, refer to Appendix A of this manual, entitled An HP-IB Overview.

HP-IB Implementation on the 7475

The HP-IB conforms to ANSI/IEEE 488-1978 specifications, and direct interconnection of the HP-IB is via a connector on the rear panel.

The HP-IB functions implemented in the 7475 are as follows:

1. Source Handshake (SH1)
2. Acceptor Handshake (AH1)
3. Talker (T6)
4. Listener (L3)
5. Service Request (SR1)
6. No Remote Local (RL0)
7. Parallel Poll (PP0 if listen-only; PP2 if addr <8; PP1 otherwise)
8. Device Clear (DC1)
9. No Device Trigger (DT0)
10. No Controller (C0)

Interface Switches and Controls

The 7475 plotter functions in either of two modes, addressable mode and listen-only mode. In addressable mode, the plotter can function as a talker or as a listener depending on the instructions it receives from the controller. In listen-only mode, it can only listen and it hears all activity on the bus.

Addressing the Plotter

Rear panel switches provide for selection of the plotter address or listen-only mode. Each HP-IB interface can have as many as 15 devices connected to it, set to different specific address codes. The plotter can be set to any one of 31 HP-IB addresses, ranging from 0 through 30. Each address can be selected by setting the switches on the rear panel to the appropriate binary bit positions for the particular address value desired. The address selected establishes the 7475's device address. When using the plotter with an HP desktop computer, do not use 21 which is reserved for the desktop computer's address. When not using an HP desktop computer, be sure the computer and plotter do not have the same address. (Refer to the documentation for your computer.) Address 31 is used to set the plotter to listen-only mode.

The plotter is set to an address code of 05 at the factory. This corresponds to a listen character of % and a talk character of E. Check the following figure for the factory-set address switch positions.

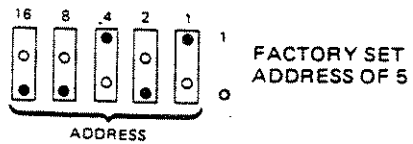

The following table lists the address switch positions for each address value.

| Address Characters | | Address Switch Settings | | | | | Address Codes | |
|--------------------|------|-------------------------|---|---|---|---|---------------|-------|
| Listen | Talk | 16 | 8 | 4 | 2 | 1 | Decimal | Octal |
| SP | @ | 0 | 0 | 0 | 0 | 0 | 0 | 0 |
| ! | A | 0 | 0 | 0 | 0 | 1 | 1 | 1 |
| " | B | 0 | 0 | 0 | 1 | 0 | 2 | 2 |
| # | C | 0 | 0 | 0 | 1 | 1 | 3 | 3 |
| \$ | D | 0 | 0 | 1 | 0 | 0 | 4 | 4 |
| % | E | 0 | 0 | 1 | 0 | 1 | 5 | 5 |
| & | F | 0 | 0 | 1 | 1 | 0 | 6 | 6 |
| ' | G | 0 | 0 | 1 | 1 | 1 | 7 | 7 |
| (| H | 0 | 1 | 0 | 0 | 0 | 8 | 10 |
|) | I | 0 | 1 | 0 | 0 | 1 | 9 | 11 |
| * | J | 0 | 1 | 0 | 1 | 0 | 10 | 12 |
| + | K | 0 | 1 | 0 | 1 | 1 | 11 | 13 |
| , | L | 0 | 1 | 1 | 0 | 0 | 12 | 14 |
| - | M | 0 | 1 | 1 | 0 | 1 | 13 | 15 |
| . | N | 0 | 1 | 1 | 1 | 0 | 14 | 16 |
| / | O | 0 | 1 | 1 | 1 | 1 | 15 | 17 |
| 0 | P | 1 | 0 | 0 | 0 | 0 | 16 | 20 |
| 1 | Q | 1 | 0 | 0 | 0 | 1 | 17 | 21 |
| 2 | R | 1 | 0 | 0 | 1 | 0 | 18 | 22 |
| 3 | S | 1 | 0 | 0 | 1 | 1 | 19 | 23 |
| 4 | T | 1 | 0 | 1 | 0 | 0 | 20 | 24 |
| 5 | U | 1 | 0 | 1 | 0 | 1 | 21 | 25 |
| 6 | V | 1 | 0 | 1 | 1 | 0 | 22 | 26 |
| 7 | W | 1 | 0 | 1 | 1 | 1 | 23 | 27 |
| 8 | X | 1 | 1 | 0 | 0 | 0 | 24 | 30 |
| 9 | Y | 1 | 1 | 0 | 0 | 1 | 25 | 31 |
| : | Z | 1 | 1 | 0 | 1 | 0 | 26 | 32 |
| ; | [| 1 | 1 | 0 | 1 | 1 | 27 | 33 |
| < | \ | 1 | 1 | 1 | 0 | 0 | 28 | 34 |
| = |] | 1 | 1 | 1 | 0 | 1 | 29 | 35 |
| > | ^ | 1 | 1 | 1 | 1 | 0 | 30 | 36 |
| ? | _ | 1 | 1 | 1 | 1 | 1 | 31 | 37 |

preset → (points to row 5)
 Reserved for HP Desktop Computer Address (points to rows 5-9)
 Sets Listen-only Mode (points to row ?)

Bus Commands

Reaction to Bus Commands DCL, SDC, and IFC

The computer can set all devices on the HP-IB system to a predefined or initialized state by sending the device clear command, DCL. The computer can also set selected devices to a predefined or initialized state by sending a selected device clear command, SDC, along with the addresses of the devices. The basic difference is that devices will obey SDC only if they are addressed to listen, whereas DCL clears all devices on the bus. The interface clear command, IFC, is used by the computer to override all bus operations and return the bus to a known quiescent state.

Upon receipt of either a DCL, SDC, or IFC command, the plotter resets the I/O to begin accepting a new instruction, and disables any current output. Any partially parsed HP-GL instruction or parameters will be lost.

The device clear and interface clear commands *do not* reset parameters in the plotter to their default values. They are not the same as the HP-GL instructions, DF or IN.

Serial and Parallel Polling

Polling is the process used by the computer to determine which device on the HP-IB bus has initiated a require service message. The conditions which will cause the require service message to be sent to the computer are defined by the input mask instruction, IM, in Chapter 1.

The Serial Poll

A serial poll enables the computer to learn the status or condition of devices on the bus. It is commonly used by the computer to determine who is requiring service.

The serial poll is so named because the computer polls devices one at a time rather than all at once. The plotter will respond to a serial poll by sending the status byte as described under the output status instruction, OS (Chapter 7). The S-mask parameter of the input mask instruction, IM, is used to specify which status byte conditions will send the service request message and when polled, respond with request service. Unless the user changes the S-mask value from the default setting of 0, the plotter will never give a positive response to a serial poll, i.e., request service (see The Input Mask Instruction, IM, Chapter 1). Bit position 6 of the status byte will be set to 1 (if the S-mask value is not 0) when any of the conditions designated by the S-mask are true. Bit position 6 will be set to 0 after all conditions which would cause a service request no longer exist. See IM, Chapter 1, and OS, Chapter 7. Until bit position 6 has been reset to 0, no additional service request messages, and therefore, no responses to a serial poll are possible.

A computer must issue special commands to initiate and terminate a serial poll. During a serial poll, a device must be instructed to talk and the computer to listen. Therefore, a serial poll cannot be executed when a plotter is in listen-only mode.

The Parallel Poll

Parallel polling can only be done to plotters with an address 0 through 7. Plotters with address settings from 8 through 30 cannot respond to a parallel poll. The plotter will respond positively to a parallel poll only if the conditions specified in the P-mask are satisfied and parallel poll response is enabled. The P-mask parameter of the input mask instruction, IM, is used to specify which status byte conditions will result in a logical 1 response to a parallel poll. The response to a parallel poll is limited to setting the appropriate data line to a logical 1. The line used is determined by the plotter's address value as shown in the table below:

| Plotter Address | Parallel Poll Bit Position | HP-IB Data Line Number |
|------------------------|-----------------------------------|-------------------------------|
| 0 | 7 | 8 |
| 1 | 6 | 7 |
| 2 | 5 | 6 |
| 3 | 4 | 5 |
| 4 | 3 | 4 |
| 5 | 2 | 3 |
| 6 | 1 | 2 |
| 7 | 0 | 1 |

Plotter Preset Address

To execute a parallel poll, the controller sets the ATN and EOI lines to 1. The controller reads the eight data lines, and determines from these lines which instrument on the bus is requesting service. The computer then sends the parallel poll disable command. Not all computers have parallel poll capability.

It is important to remember that the 7475 will not send a logical 1 unless the P-mask bit value has been changed from the default value of 0 and some condition included in the new P-mask value is true. The plotter does not respond to a parallel poll in listen-only mode.

Positive responses to parallel polls will continue to occur until all bits of the status byte included in the P-mask value have been reset to 0. (See The Output Status Instruction, OS, Chapter 7.)

Addressing the 7475 as a Talker or Listener

To communicate effectively with the 7475 plotter, it is important that you completely understand the addressing protocol of your computer. Therefore, you may wish to review this aspect of your computer before proceeding.

Computers with No High Level I/O Statements

On low level computers, addressing devices on the HP-IB bus is accomplished using mnemonics, such as CMD, which serve as the "bus command."

When bus commands are necessary, a typical addressing sequence is

<Unlisten Command> <Talk Address> <Listen Addresses>

This sequence is made up of three major parts which serve the following purposes:

1. The unlisten command is the universal bus command with a character code of "?". It unaddresses all listeners. After the unlisten command is transmitted, no active listeners remain on the bus.
2. The talk address designates the device that is to talk. A new talk address automatically unaddresses the previous talker.
3. The listen addresses designate one or more devices that are to listen. A listen address adds the designated device as listener along with other addressed listeners.

This basic addressing sequence simply states who is to talk to whom. The unlisten command ("?") plays a vital role in this sequence. It is important that a device receive only the data that is intended for it.

When a new talk address is transmitted in the addressing sequence, the previous talker is unaddressed. Therefore, only the new talker can send data on the bus and there is no need to routinely use an untalk command in the same manner as the unlisten command.

Computers with High Level I/O Statements

In more powerful computers, higher level input/output (I/O) statements are used to specify device addresses on the HP-IB bus. In these cases, the addressing protocol (unlisten, talk, listen) is a function of the computer's internal operating system and need not be of concern to the user.

Sending and Receiving Data

Computer-to-Plotter

Transmitting data from a computer to the plotter is typically accomplished using I/O statements such as WRITE, PRINT, PRINT#, or OUTPUT. The following examples of sending program data to the plotter from various computers are only intended to illustrate the necessity for understanding the I/O statement protocol implemented by your computer. Each of these examples will cause the plotter to label the identity of the computer sending data, beginning at the X,Y coordinates 1000,2000. The examples involve sending both character string and numeric data as variables, and constants or literals.

HP 9825 and 9826 HPL Example:

```
0: fxd 0;dim A$(13)
1: " SENDING DATA"→A$
2: 2000→Y
3: 9826→B
4: wrt 705,"SP1;PA1000,",Y
5: wtb 705,"LBHP",str(B),A$,3
6: end
```

A terminator is sent by the 9825/9826 at the end of a wrt statement.

Result: HP 9826 SENDING DATA

9826 BASIC Example:

```
10 PRINTER IS 705
20 A$=" SENDING DATA"
30 B=9826
40 Y=2000
50 PRINT "SP1;PA1000,",Y
60 PRINT USING "K";"LBHP ",B,A$,"&"
70 END
```

A terminator is sent by the 9826 at the end of a PRINT statement.

Result: HP 9826 SENDING DATA

HP 9835/9845 Example:

```
10 PRINTER IS 7,5
20 A$=" SENDING DATA"
30 B=9835
40 C=9845
50 Y=2000
60 PRINT "SP1;PA1000,";Y
70 PRINT USING "K";"LBHP ",B,"/",C,A$,CHR$(3)
80 END
```

A terminator is sent by the computer at the end of a PRINT statement.

Result: HP 9835/9845 SENDING DATA

HP 2647 Example:

```
10 ASSIGN "H#5" TO #1
20 DIM A$(13)
30 A$="SENDING DATA"
40 B=2647
50 Y=2000
60 PRINT #1;"SP1;PA1000,";Y
70 PRINT #1;"LBHP",B,A$,CHR$(3)
80 END
```

A terminator is sent by the 2647 at the end of PRINT #1 statements.

Result: HP 2647 SENDING DATA

HP-83/85 Example:

```
10 PRINTER IS 705
20 A$="SENDING DATA"
30 B=85
40 Y=2000
50 PRINT "SP1;PA1000,";Y
60 PRINT "LBHP";B;A$;" "
70 END
```

A terminator is sent by the computer following PRINT statements.

Result: HP 85 SENDING DATA

TEK 4051 Example:

```
100 DIM A$(13),B$(1)
110 A$=" SENDING DATA
120 Y=2000
130 B=4051
135 B$=CHR(3)
140 PRINT @5:"SP1;PA1000,";Y;" ";
150 PRINT @5:"LBTEK";B;A$;B$
160 END
```

No terminator is sent by the TEK 4051. It must, therefore, be included in each PRINT @ 5 statement if the last HP-GL instruction in the line requires one. In line 140, all characters after the Y may be omitted, since the terminator is optional with the PA instruction.

Result: TEK 4051 SENDING DATA

Commodore PET* 2001 and CBM* 8032 Example:

```
10 OPEN 5,5
20 DIM A$(13)
30 A$=" SENDING DATA"
40 B=2001
50 Y=2000
60 PRINT#5,"SP1;PA1000,";STR$(Y)
70 PRINT#5,"LBPET ";B;A$;CHR$(3)
80 END
```

A terminator is sent by the computer at the end of the PRINT #5 statement.

Result: PET 2001 SENDING DATA

Apple* II Applesoft BASIC Example:

```
10 PR# 3: IN# 3
20 Z$= "WT%" + CHR$(26)
30 DIM A$(12)
40 A$= " SENDING DATA"
50 Y= 2000
60 PRINT Z$; "SP1;PA1000,";Y
70 PRINT Z$; "LBAPPLE II ";A$;CHR$(3)
80 PR# 0: IN# 0
90 END
```

*Commodore PET and CBM are trademarks of Commodore Business Machines, Inc. Apple is a trademark of Apple Computer, Inc.

Result: **APPLE II SENDING DATA**

The PR# 3: IN# 3 statement must be included in each program before instructions can be sent to the plotter. These statements assume the IEEE-488 interface card (HP-IB) is in slot three of the computer. The string Z\$ addresses the plotter at address 5 to listen. It must be included in every print statement which sends HP-GL commands to the plotter. The PR# 0: IN# 0 statement directs keyboard output to the display and must be included before the end of the program or before anything can be printed on the display.

Plotter-to-Computer

Outputting data from the plotter to the computer is typically accomplished using I/O statements such as READ, INPUT, or ENTER. Sometimes these statements are only available in I/O ROMs; check your computer's documentation or ask your HP dealer or HP Sales and Support Office. The following examples of obtaining output data from the plotter using various computers are only intended to illustrate the necessity for understanding the I/O statement protocol implemented on your computer. Each of these examples commands the pen to move to plotter coordinates X = 1000, Y = 1000 and then output the current pen position and the plotter identifier string to the computer.

HP 9825 and 9826 HPL Example:

```
0: fxd 0;dim A$(5)
1: wrt 705,"PA1000,1000;0C"
2: red 705,A,B,C
3: wrt 705,"OI"
4: red 705,A$
5: dsp A,B,C,A$
6: end
```

Displayed current pen position and identification.

1000 1000 0 7475A

HP 9826 BASIC Example:

```
10 PRINTER IS 705
20 PRINT "PA1000,1000;0C"
30 ENTER 705;A,B,C
40 PRINT "OI"
50 ENTER 705;A$
60 DISP A,B,C,A$
70 END
```

Displayed current pen position and identification.

1000 1000 0 7475A

HP 9835/9845 Example:

```
10 PRINTER IS 7,5
20 PRINT "PA1000,1000;0C"
30 ENTER 705;A,B,C
40 PRINT "0I"
50 ENTER 705;A$
60 DISP A,B,C,A$
70 END
```

Displayed current pen position and identification.

```
1000          1000          0
```

7475A

HP 2647 Example:

```
10 ASSIGN "H#5" TO #1
20 PRINT #1;"PA1000,1000;0C"
30 READ #1;A,B,C
40 PRINT #1;"0I"
50 READ #1;A$
60 PRINT A,B,C,A$
70 END
```

Displayed current pen position and identification.

```
1000          1000          0
```

7475A

HP-85/86/87 Example:*

```
10 PRINTER IS 705
20 PRINT "PA1000,1000;0C"
30 ENTER 705 ; A,B,C
40 PRINT "0I;"
50 ENTER 705 ; A$
60 DISP A,B,C,A$
70 END
```

Displayed current pen position and identification.

```
1000          1000
0              7475A
```

*Requires I/O ROM, HP Part No. 00087-15003.

TEK 4051 Example:

```
100 DIM A$(5)
110 PRINT @5:"PA1000,1000;0C;"
120 INPUT @5:A,B,C
130 PRINT @5:"OI;"
140 INPUT @5:A$
150 PRINT A,B,C,A$
160 END
```

Displayed current pen position and identification.

1000 1000 0 7475A

Commodore PET 2001 Example:

```
10 OPEN 5,5
20 PRINT#5,"PA1000,1000;0C"
30 INPUT#5,A,B,C
40 PRINT#5,"OI"
50 INPUT#5,A$
60 PRINT A,B,C,A$
70 END
```

Displayed current pen position and identification.

1000 1000 0 7475A

Commodore CBM 8032 Example:

On the CBM 8032, all alphabetic characters are displayed as lowercase. This is true for both BASIC program statements and for the plotter's response.

A dummy string variable should be included at the end of every input statement which reads data from the plotter because the CBM 8032 sends an untalk command after it receives a carriage return character. Since the plotter with an HP-IB interface terminates all output with a carriage return followed by a line feed, the line feed must be read into this dummy string variable in order to clear the plotter's output buffer for future output.

```
10 OPEN 5,5
20 PRINT#5,"PA1000,1000;0C"
30 INPUT#5,A,B,C,B$
40 PRINT#5,"OI"
50 INPUT#5,A$,B$
60 PRINT A,B,C,A$
70 END
```

Displayed current pen position and identification.

1000 1000 0 7475a

Apple II Applesoft BASIC Example:

```
10 PR# 3: IN# 3
20 Z$= "WTZ" + CHR$ (26)
30 Y$= "RDE" + CHR$ (26)
40 PRINT Z$; "PA1000,1000;0C;"
50 PRINT Y$;
60 INPUT A,B,C
70 PRINT Y$;
80 INPUT D$
90 PRINT Z$; "OI"
100 PRINT Y$;
110 INPUT A$
120 PRINT Y$
130 INPUT D$
140 PR# 0: IN# 0
150 PRINT A,B,C,A$
160 END
```

Displayed current pen position and identification.

1000 1000 0
7475A

For an explanation of PR# 3, Z\$ and PR# 0, refer to the Apple II example in the prior section. The string Y\$ instructs the plotter at address 5 to talk. The Apple II sends an untalk command after it receives a carriage return character. The plotter with an HP-IB interface terminates all output with a carriage return followed by a line feed. Therefore, in order to clear the plotter's buffer for future output, another talk instruction and another input statement containing a dummy variable (D\$ in this program) must follow the input statement which reads parameters of the plotter output statement. The additional talk and input instructions will read the line feed character, thus clearing the plotter's buffer.

Chapter 10

RS-232-C/CCITT V.24 Interfacing

What You'll Learn in This Chapter

This chapter is only for 7475 owners with an RS-232-C interface. HP 7475s with Option 001 have an RS-232-C interface.

This chapter describes how to connect the plotter, terminal, and computer in a modem or hardwire environment. It also discusses connecting the interface, pin allocations in the connector, baud rates, stop bits, and transmission errors. It explains four possible operating modes: normal and block modes, and switched lines and leased lines monitoring modes. A tutorial description of the four handshaking methods, hardwire handshake, Xon-Xoff handshake, enquire/acknowledge handshake, and software checking handshake, is included. The last part of the chapter is devoted to the 14 device control instructions. The syntax of device control instructions is given, followed by a detailed section on each instruction. It is important to be able to use these instructions properly to establish communications with the plotter in your operating environment. You need to master the material in this chapter so you can successfully send HP-GL instructions to the plotter.

NOTE: All information in this chapter applies equally to RS-232-C and CCITT V.24 interfaces. For purposes of simplicity, both are referred to as RS-232-C. ■

Setting Up Your RS-232-C Plotter: a Checklist

The following steps should be followed when interfacing the 7475 plotter with a computer using an RS-232-C interface.

1. Determine which installation and operating environment, described in the first few pages of this chapter, matches your system.
2. Check that you have the required cables and connect the plotter as pictured in the section which describes the environment chosen in step 1. Information necessary when constructing your own cable is found in the section Connecting the RS-232-C Interface.
3. Determine if parity checking is used on your system and set the rear panel parity switches **S1** and **S2** accordingly. Refer to the 7475 Operation and Interconnection Manual.
4. Determine the baud rate at which your computer sends data and set the rear panel switches **B1** through **B4** accordingly. Refer to the 7475 Operation and Interconnection Manual.
5. Determine which handshake your system uses. The four kinds of handshakes are described in the section entitled Handshaking. Note which device control instructions are used to establish that handshake. Since handshaking is often a function of your operating system, you may need to refer to the manuals for your computer to determine which parameters you must set and to what values.
6. In the last part of this chapter, read about the instructions you will use to set up the handshake you have chosen.

Plotter Environments

There are three possible ways to position the 7475 plotter in a computer system. They are described in the following pages; you need only read the section which applies to your system.

Once the plotter has been connected in a system, it can be placed in an operating state. The operating states which can be accessed in a given environment are described in the operation section for each of the three environments.

Using a Plotter Directly Connected to a Computer Mainframe or Personal Computer

Installation

In this type of system, the plotter is connected directly to a computer and is usually adjacent to it. Entry to the computer is by a keyboard or

terminal through a separate port, rather than through the plotter. This is sometimes referred to as an endline or stand-alone environment. Diagrams of this type of system for both large and personal computers are shown below, along with a picture of the rear panel connection.

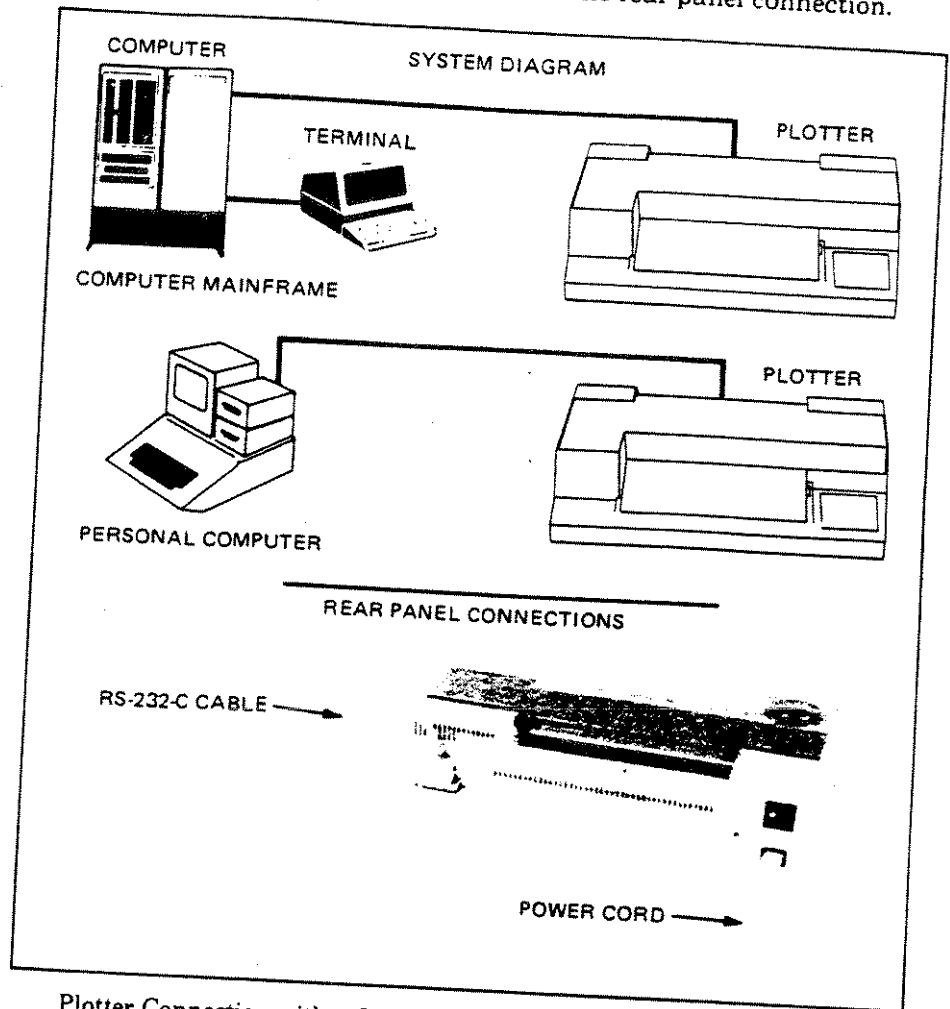

Plotter Connection with a Computer Mainframe or Personal Computer

Operation

Operation with this type of installation is usually confined to the on-line, programmed-on state. The rear panel switch labeled γ/\mathcal{D} should be set to \mathcal{D} (direct). When the switch is set to \mathcal{D} , whenever power is being applied to the plotter, it is in the on-line, programmed-on state. In this state, the plotter reacts to all device control and HP-GL instructions except the plotter off instruction. It is not possible to programmatically turn the plotter off. Only when the switch is set to γ may the plotter be

placed in the on-line, programmed-off mode. That operating state is described under operation with a terminal.

Using a Plotter in an Environment with a Terminal

Installation

In the second type of system, the plotter is connected in series between the computer and the terminal. The plotter's **LINE** switch must be **ON** in order to have any communication between the terminal and the computer. There may be a direct wire between the computer and the plotter or the plotter may be connected to a modem and communication may take place over telephone lines. This setup, with the plotter between the computer and the terminal, is sometimes referred to as eavesdrop environment. A special Y-cable (Part No. 17455A), which joins the lines from the computer and terminal into the plotter's one connector, must be used in this environment. Diagrams of the two systems, with and without a modem, follow, along with pictures of the rear-panel connections for both kinds of systems.

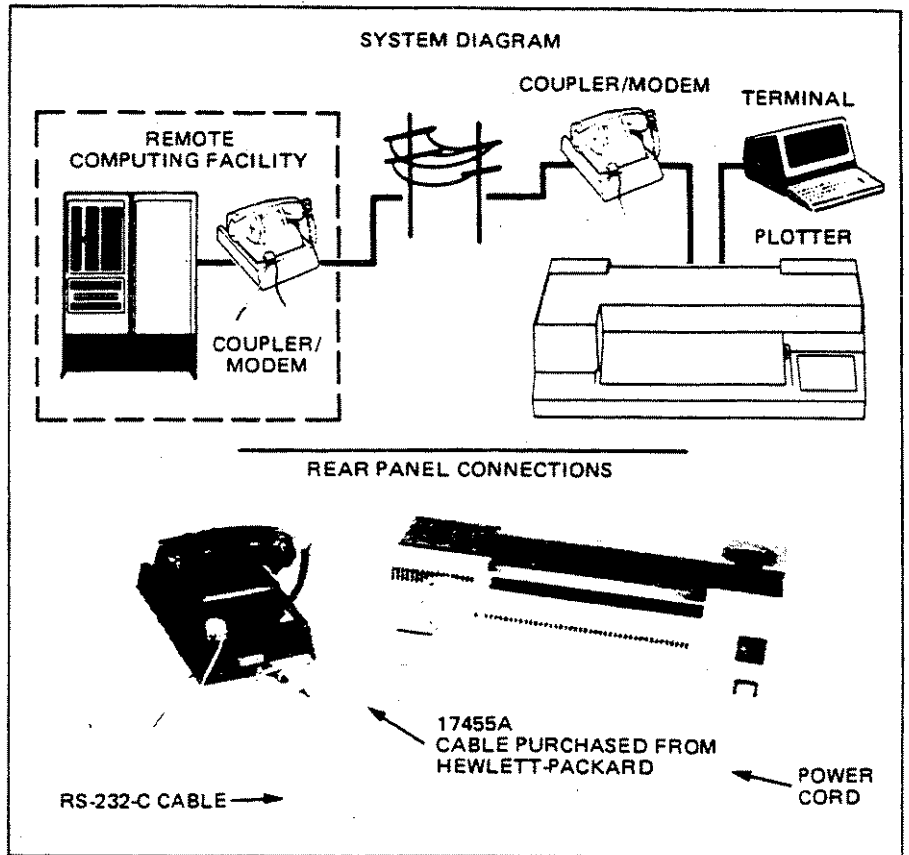

Plotter Interconnection with a Terminal and Remote Facility Using Modems

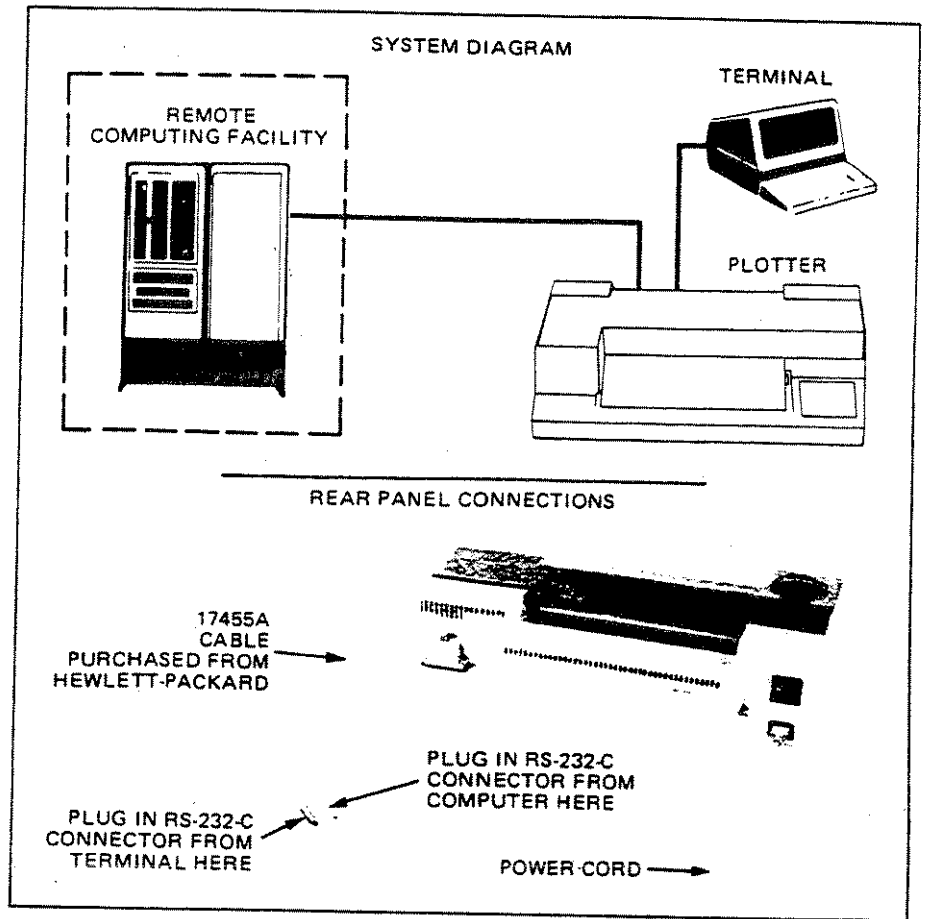

Plotter Interconnection with a Terminal and Remote Facility
Using RS-232-C/CCITT V.24 Cabling

Operation

While operating in this environment, the plotter may be in one of three states: on-line, programmed-off; on-line, programmed-on; or monitor mode.

On-Line, Programmed-Off State

The plotter can only be in this state if the \forall/D switch on the rear panel is set to \forall (used with Y-cable). When this switch is set to \forall , the plotter is placed in the on-line, programmed-off state by either turning the plotter's **LINE** switch to **ON** or by receipt of a plotter off instruction from the computer or of a terminal-generated Break signal while the plotter is in the on-line, programmed-on state. In the on-line, programmed-off state, the plotter's processor passes data between the computer and the terminal as shown in the following diagram. The plotter will respond only to a plotter on instruction from the host computer.

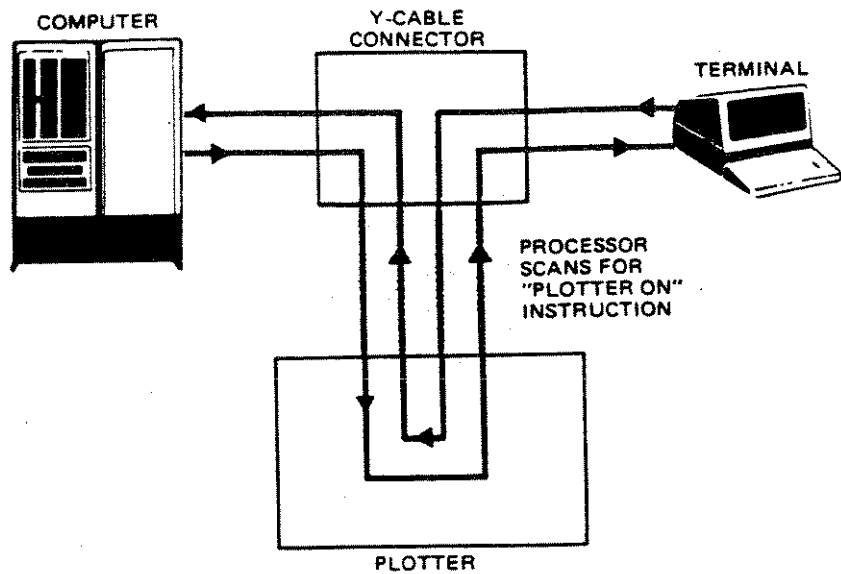

Plotter in On-Line, Programmed-Off State

On-Line, Programmed-On State

When the rear-panel switch labeled Y/D is set to D, the plotter is placed in the on-line, programmed-on state by turning on the plotter. When the Y/D switch is set to Y, the plotter is switched from the on-line, programmed-off state to the on-line, programmed-on state when a plotter on instruction, ESC . (or ESC . Y, is received from the computer.

When in this state, the plotter operates in response to instructions received from the computer as shown in the following figure. When the plotter instructions request output, it is provided as shown. The communication channel from the terminal to the computer, through the plotter, is maintained to provide operator entry into the computer.

The plotter's processor monitors the channel from the terminal to the computer for a terminal-generated Break signal. The plotter will interpret anything greater than a 130-millisecond space as a Break. This Break signal is retransmitted to the computer and in-process plotter outputs are aborted, but plotting continues until stored buffer data is completed. A new plotter on instruction from the computer is required to resume plotting operations. The plotter will ignore a Break signal if the Y/D switch is set to D.

It should be noted that in the on-line, programmed-on state (but not in monitor mode which is described in the next paragraph) all data generated by the terminal are routed through to the computer on a noninterference basis when the plotter is not doing outputs. Data generated by the terminal are ignored while output is occurring. However, all data generated by the computer are intercepted by the plotter and not passed to the terminal.

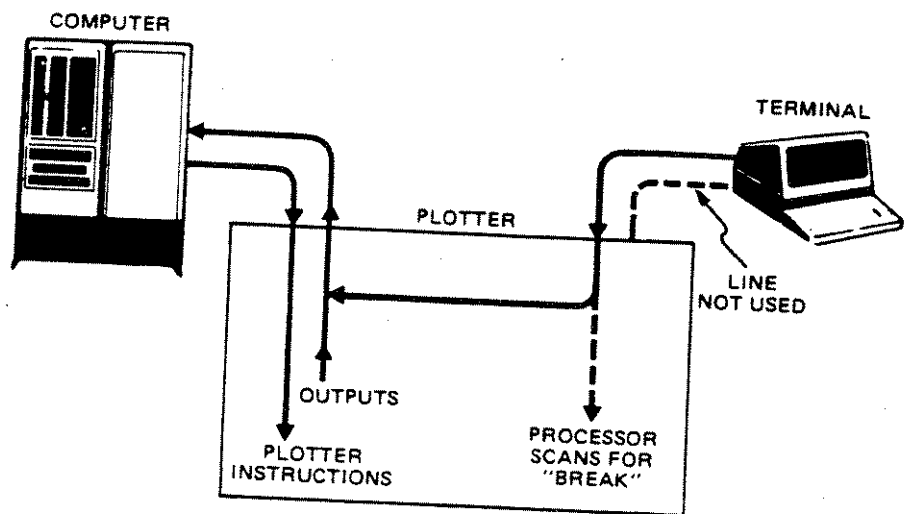

Plotter in On-Line, Programmed-On State

Monitor Mode

After the plotter is in the on-line, programmed-on state, two mutually exclusive monitor modes may be enabled using the set plotter configuration instruction, ESC . @. Depending upon which monitor mode is enabled, either all data (including device control instructions) are retransmitted to the terminal CRT or only HP-GL data are retransmitted as they are parsed from the plotter's buffer. All plotter output responses are sent to both the computer and terminal. Refer to The Set Plotter Configuration Instruction, ESC . @, for complete information.

The plotter monitors for a terminal-generated Break signal. Receipt of a Break signal will cause the same results as described under the on-line, programmed-on state. Then, new plotter on and set plotter configuration instructions from the computer are required to resume plotting operations with monitor mode active. The following diagram shows how the plotter processes data while in monitor mode.

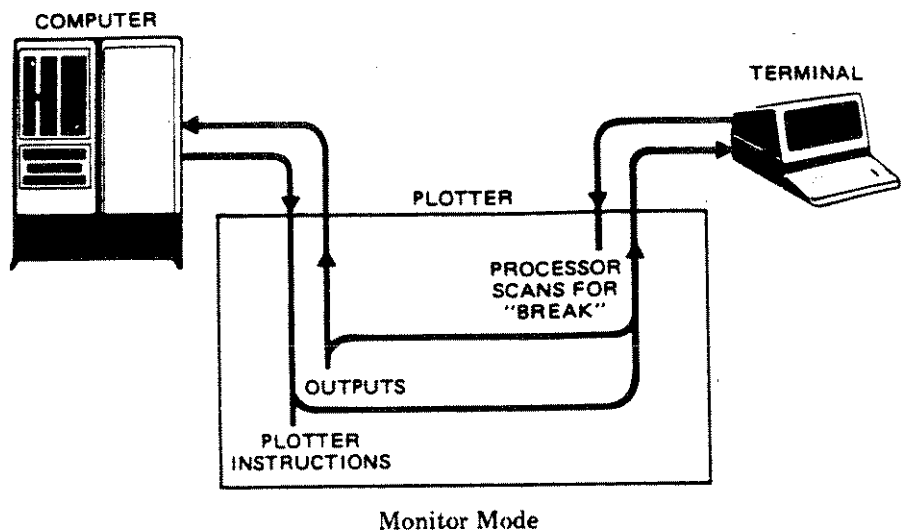

Using the Plotter in a Terminal-only Environment

Installation

The 7475 plotter can be directly connected to a terminal if a specially constructed, user-supplied cable is used that cross connects lines 2 and 3. While there is no computer in this configuration, the terminal usually has some "intelligence." When the terminal and plotter are connected using this special cable, the terminal may be used to send instructions to the plotter. A diagram of the terminal-only environment and a picture showing the rear-panel connection follow.

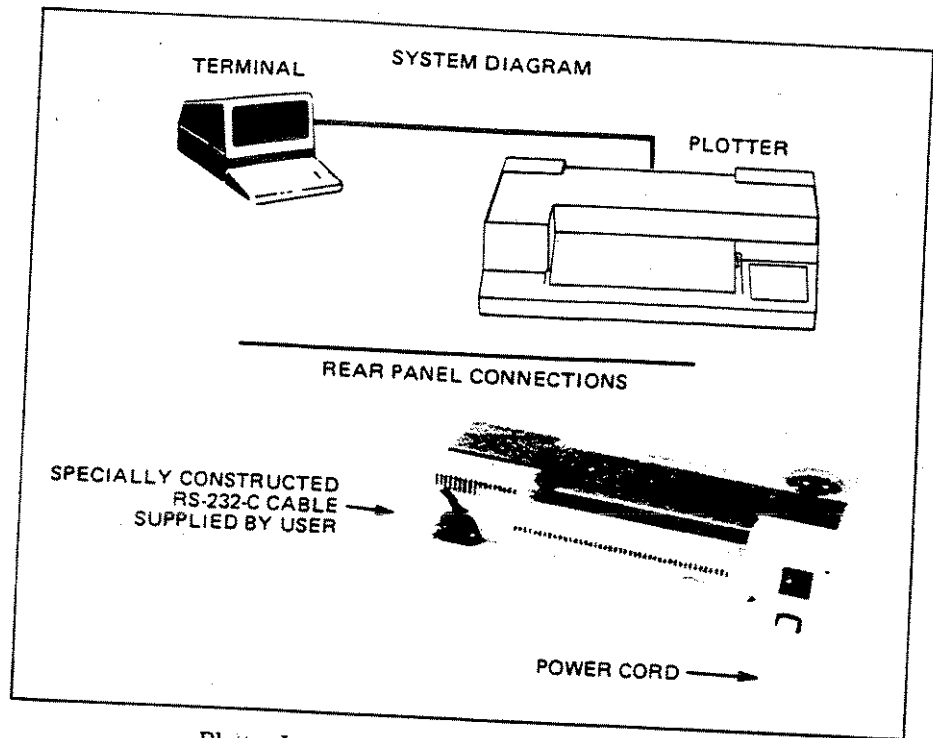

Plotter Interconnection with Only a Terminal

Operation

The rear-panel switch labeled γ/\mathbf{D} should be set to \mathbf{D} . If it is set to γ , the plotter must receive a plotter on instruction, ESC . (or ESC . Y, before it will respond to other instructions from the terminal. The terminal should be set to half duplex in order to view the characters being sent to the plotter. Plotter output will be displayed on the terminal. The following diagram shows plotter operation when in the programmed-on state in a terminal-only environment.

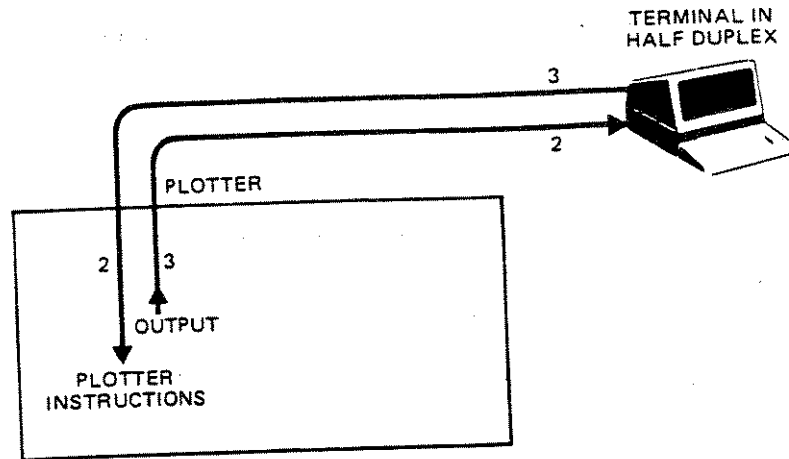

Terminal-only Environment, Programmed On

Connecting the RS-232-C Interface

The 7475 plotter interfaces to the RS-232-C communications lines through a standard 25-pin female connector mounted on the back of the plotter. The 7475 is capable of operating in a three-wire (transmit, receive, ground) configuration.

In hardwired handshake operation, the Data Terminal Ready line (pin 20 of the connector on the plotter) is used to monitor the space in the buffer available for input. The plotter outputs data when requested (refer to Hardwire Handshake in this chapter).

If you are fabricating the cable assembly, the connector should be a 25-pin type "D" subminiature CINCH DBC-25P plug or equivalent.

Connector pin allocations for the three-wire configuration are identified and described in the following table.

Minimum Interface Connector Pin Allocations

| Pin No. | RS-232-C | CCITT V.24 | Function/Signal Level |
|---------|----------|------------|---|
| 2 | BA | 103 | Transmitted Data High = SPACE = "0" = +12 V Low = MARK = "1" = -12 V |
| 3 | BB | 104 | Received Data High = SPACE = "0" = +3 V to +25 V Low = MARK = "1" = -3 V to -25 V |
| 7 | AB | 102 | Signal ground (Common return) |

In addition to the minimum requirements for communication, ten more lines are connected as shown in the following table. These lines are required to implement full duplex communication, intermediate baud rate, hardwired handshake mode, and monitor mode. All remaining pins make no internal connection.

Pins 14 and 16 are wired in the special Y-cable, available as Option 16, to implement monitor mode. The Y-cable schematic is shown below.

NOTE: Hardwire handshake **cannot** be used to prevent buffer overflow when the Y-cable is connected. This is because pin 20 is connected between the **COMPUTER** and **TERMINAL** connectors, but not to the **PLOTTER** connector. ■

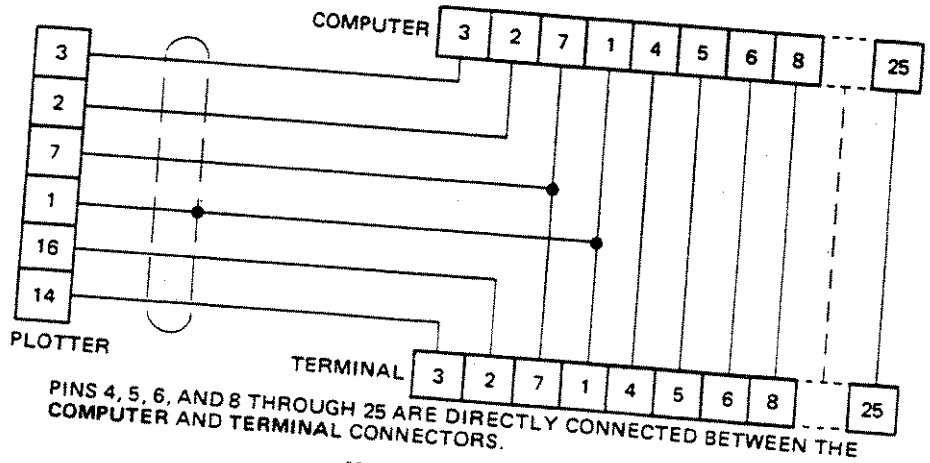

Y-cable Schematic

Additional Connector Pin Allocations

| Pin No. | RS-232-C | CCITT V.24 | Function/Signal Level |
|---------|----------|------------|---|
| 1 | AA | 101 | Protective ground |
| 4 | CA | 105 | Request To Send from the plotter Always High = ON = +12 V |
| 5 | CB | 106 | Clear to Send High = ON = +3 V to +25 V Low = OFF = -3 V to -25 V |
| 6 | CC | 107 | Data Set Ready High = ON = +3 V to +25 V Low = OFF = -3 V to -25 V |
| 8 | CF | 109 | Received Line Signal Detector High = ON = +3 V to +25 V Low = OFF = -3 V to -25 V |
| 17 | DD | 115 | External Clock Input High = ON = +3 V to +25 V Low = OFF = -3 V to -25 V |
| 20 | CD | 108.2 | Data Terminal Ready to modem High = ON = +12 V Low = OFF = -12 V |
| 23 | CH/CI | | Data Signal Rate Selector Always High = ON = +12 V |
| 14* | SBA | 118 | Secondary Transmit Data Data line from plotter to terminal |
| 16* | SBB | 119 | Secondary Received Data Data line to plotter from terminal |

*Used to establish monitor mode with special Y-cable (Part No. 17455A).

For FTZ/European applications, two additional modes are available: switched lines monitoring mode and the leased lines monitoring mode.

In the switched lines monitoring mode, the CC and CB will be monitored. If either of these lines go low, the CD line will be driven low by the plotter to automatically disconnect the channel from the line. This mode is enabled by depressing the pen 5 pushbutton on the front panel during power-up.

In the leased lines monitoring mode, the CC, CB, and CF will be monitored. If any of these lines go low, the CD line will be driven low by the plotter to automatically disconnect the channel from the line. This mode is enabled by depressing the pen 6 pushbutton on the front panel during power-up.

If none of the pen pushbuttons are depressed at power-up, the plotter is in normal mode (3-wire mode).

NOTE: If you are using an eavesdrop cable and you set up a switched line monitoring mode or a leased lines monitoring mode, the plotter will not be able to monitor the other signal lines such as CB, CC, CF, and DTR, and you will not be able to output data. Also, if either switched lines monitoring mode or leased lines monitoring are operational, you cannot use hardwire handshake. ■

Output Baud Rate

The plotter is designed to operate in an asynchronous mode with switch-selectable baud rates of 75, 110, 150, 200, 300, 600, 1200, 2400, 4800, and 9600. However, setting all **BAUD** switches to zero and connecting an external clock input to pin 17 of the connector allows operation of the plotter at any intermediate baud rate up to 9600 baud. Both the receiver (RRC) and transmitter (TRC) clocks will operate at the same clock rate. Requirements for the clock signal are as follows:

1. The clock frequency must be 16 times the desired baud rate.
2. The baud rate must not exceed 9600.
3. The duty cycle of the clock pulse should be close to 50%.
4. The clock pulse must be a logic on of $+2\text{ V} < V < 25\text{ V}$ and a logic off of $-25\text{ V} < V < +0.8\text{ V}$ (3.5 k Ω input impedance).
5. Care should be taken to keep the transmission lines as short as possible to minimize transmission line reflection noise.

Stop Bits

The plotter is configured to automatically verify or generate one or two stop bits, depending on the setting of the plotter's baud rate switches. Refer to the 7475A Operation and Interconnection Manual for more information.

Transmission Errors

Transmission errors occur when communication between the computer and plotter is incomplete or does not conform to what is expected or required by either party.

Transmission errors include:

- Framing error — the plotter does not detect a valid stop bit at the end of every character.
- Parity error — the plotter does not detect the expected parity (odd or even).
- Overrun error — a plotter instruction writes over another instruction.
- Buffer overflow error — the plotter receives more bytes of data than it has space for in the buffer.

When the plotter detects a framing, parity, or overrun error, it turns on the front panel **ERROR** light and sets error code 15. This error code generally indicates that the communication incompatibility is hardware related (incorrect stop bit jumper installation, wrong parity selection, incompatible or incorrectly set baud rates, etc.).

When the plotter detects a buffer overflow, it turns on the front panel **ERROR** light and sets error code 16. The last HP-GL data that caused the overflow will be lost. Error code 16 generally indicates an improperly established handshake protocol.

The **ERROR** light remains on until either the user interrogates the plotter via an output extended error instruction, **ESC . E**, and the plotter responds with the appropriate error code, or the user turns the plotter off, or an HP-GL initialization instruction, **IN**, is processed, or a front-panel reset occurs.

A complete list of error codes is included with the discussion of the **ESC . E** instruction.

NOTE: A buffer overflow condition may also cause an HP-GL error to occur. In this case, an HP-GL **IN** or **OE** instruction or a front-panel reset must be executed in order to clear the **ERROR** light. See Chapter 7 for an explanation of the output error instruction, **OE**. ■

Handshaking

The 7475 uses a 1024-byte input buffer to synchronize the processing of data with the rate at which it is received. The presence of an input buffer requires that the computer and the plotter transfer information to one another in such a way that data will not be lost or misinterpreted. This is the purpose of handshaking.

The 7475 is capable of using any one of four handshaking methods to prevent buffer overflow and the resulting loss of data. The computer system's capabilities and requirements dictate which handshake method is appropriate.

- **Hardwire Handshake** — uses a physical wire, pin 20 of the RS-232-C cable, to control handshaking. It can be used if the computer system can or does monitor pin 20 (DTR).
- **Xon-Xoff Handshake** — is managed by the peripheral device. It can be used if the computer system follows an Xon-Xoff protocol (control characters are transmitted from the peripheral to the computer).
- **Enquire/Acknowledge Handshake** — is managed by the computer system and interface. This handshake is often used in Hewlett-Packard systems and is so named because the ASCII characters ENQ and ACK may be used to control the handshake.
- **Software Checking Handshake** — is managed by the applications programmer. It can be used on almost any computer system, but it must be used if the system cannot implement any of the other three handshaking methods.

Once the handshake method is selected, the 7475 can be programmatically instructed to match the computer system requirements, implement the chosen handshake method, and function properly within the system-dependent communication environment. This is done by specifying certain variables in device control instructions which are issued to the 7475 at the beginning of each computer session or graphics program. The variables, which may be specified by using the decimal value of the character desired to establish one of the four handshake methods available to the 7475, are:

- **Output Trigger Character** — The output trigger character, when used, is the last character output by the computer when making a request of a graphics peripheral. Defining this character in an instruction tells the plotter, "Don't respond to my request until you receive this trigger character." This character is often a DC1 (decimal equivalent 17) or some other nonprinting ASCII character such as LF or CR or, when using some implementations of BASIC, the ? (decimal equivalent 63), which does print.

- **Turnaround Delay** — The turnaround delay is the length of time the plotter will wait after receiving a computer request and the trigger character, if any, before it responds. The purpose of this time delay is to delay the plotter's transmission of requested data until the computer is ready to receive and process it. Systems may require either a turnaround delay or a trigger character, or both.
- **Output Initiator Character** — The output initiator character is a one-character initiator that is sent by the plotter at the beginning of a string. The output initiator tells the computer, "This starts my transmission." Some computers which require an output initiator expect the start-of-text character, STX (decimal equivalent 2), as the plotter's output initiator.
- **Output Terminator** — The output terminator is a one- or two-character terminator that the computer requires the plotter to send at the end of each response to a data request. The output terminator tells the computer, "This completes my transmission." Often, computers expect the carriage return character, CR (decimal equivalent 13), as the plotter's output terminator.
- **Echo Terminate Character** — Echoing is commonly found in full duplex systems. Use of the echo terminate parameter in a device control instruction tells the plotter that the computer will echo all responses and that this echoed data should be ignored (the plotter's data buffer should be closed) until an echo terminate character is received. When the plotter receives the echo terminate character, it reopens the data buffer to receive graphics data from the computer. Computers often use the line feed character, LF (decimal equivalent 10), as the echo terminator. If the computer does not echo the peripheral's response, this variable must be zero (equivalent to null) or must be omitted.
- **Intercharacter Delay** — Some computers cannot process data as fast as the plotter can transmit it due to limited buffering in the I/O port. This can be compensated for by delaying each transmission from the plotter a period of time as specified by the intercharacter delay variable. This intercharacter delay is added to a turnaround delay (if one has been specified) before the first character is sent by the plotter, and is also inserted before each subsequent character in a string being sent to the computer.
- **Enquiry Character** — In some systems the computer sends an enquiry character to ask the plotter if it has room for a block of data, thereby initiating the handshake process. If Xon-Xoff handshake mode is to

be established, a NULL character (decimal equivalent 0) must be specified as the enquiry character. If enquire/acknowledge is to be established, an ENQ character (decimal equivalent 5) or any other ASCII character besides the NULL is used.

- **Immediate Response String** — Certain system environments require an immediate response from the plotter acknowledging the enquiry from the computer. Systems of this type include a computer that transmits data to the plotter after a certain time interval but before receiving a go-ahead signal from the plotter. If the plotter's buffer is full and the computer sends more data, the buffer will overflow. The immediate response string prevents this inadvertent transmission of data before the plotter is ready. It is transmitted by the plotter immediately after receipt of an enquiry character and tells the computer, "Wait, I am here and checking my buffer space." Computers frequently require a DC3 character (decimal equivalent 19) for the immediate response.
- **Acknowledgment String** — The acknowledgment string specifies the character or characters that the plotter will send to the computer when the plotter's input buffer has room for another block of data. Computers frequently require that the ACK character (decimal equivalent 6) be used for the acknowledgment string.
- **Data Block Size** — This is the maximum size of each data block the computer will transmit to the plotter.
- **Data Terminal Ready (CD) Line Control** — This variable sets the configuration of the plotter's Data Terminal Ready control line (pin 20) to enable or disable the hardwire handshake mode. Pin 20 is held on (+12 V) if hardwire handshake is disabled.
- **Xoff Threshold Level** — In the Xon-Xoff handshake mode this defines how many empty bytes remain in the buffer when the plotter sends the Xoff trigger character to the computer, telling it to stop sending data.
- **Xoff Trigger Character** — This specifies the character string the plotter will use to signal the computer to temporarily stop sending data while the plotter processes what it has already received. The DC3 character (decimal equivalent 19) is generally used for the Xoff trigger.
- **Xon Trigger Character** — This specifies the character string the plotter will use to signal the computer that there is sufficient space in the buffer to resume sending data. The DC1 character (decimal equivalent 17) is generally used for the Xon trigger.

The following discussion of the four handshake methods includes the pertinent variables and identifies the instructions which will establish their values.

Software Checking

Software checking is a nonautomatic handshake method in which the user's program repeatedly asks the plotter how many characters of empty space remain in the buffer. When the plotter response is bigger than the next block of data, the program will transmit the data block to the plotter. This method is inefficient in time-share environments.

The advantage of software checking is that it is independent of hardware and operating system abilities required to implement other handshake modes; therefore, it usually makes software transportable between computer systems. The limitation of this method of handshaking is that it uses up computer time.

To match the requirements of the computer system, these variables may be specified for the software checking handshake mode by using the appropriate instruction:

- Turnaround delay (ESC . M instruction)
- Output trigger character (ESC . M instruction)
- Echo terminate character (ESC . M instruction)
- Output initiator character (ESC . M instruction)
- Output terminator (ESC . M instruction)
- Intercharacter delay (ESC . N instruction)

The following flow diagram illustrates the functional elements of a typical software checking handshake within a user's program.

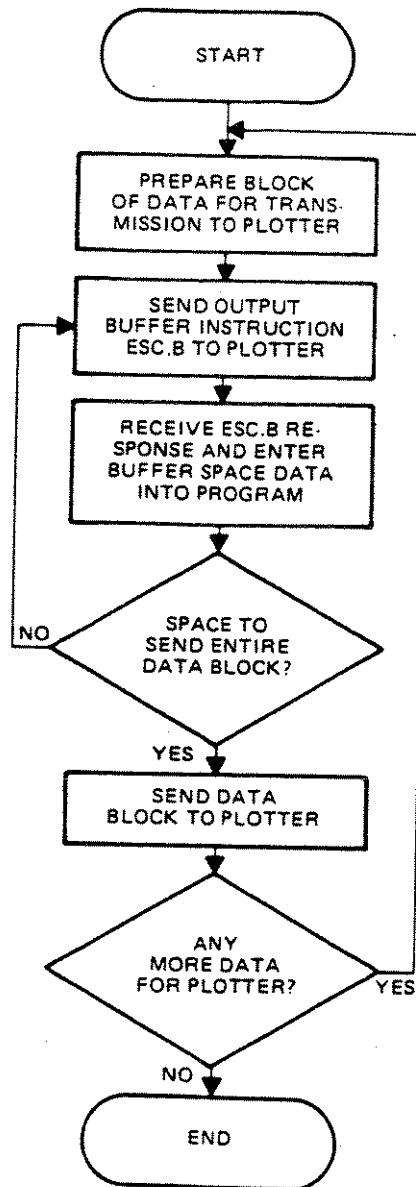

Xon-Xoff Handshake

With the Xon-Xoff handshake method, the plotter controls the data exchange sequence by telling the computer when it has room in its buffer for data and when to shut off the flow. The plotter uses buffer threshold indicators (an Xon trigger character and an Xoff trigger character) to prevent buffer overflow.

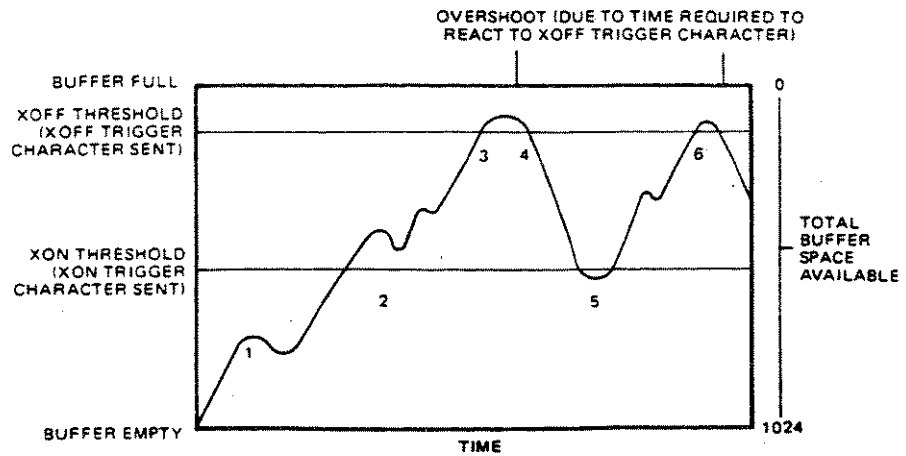

Xon-Xoff Threshold Levels

As data is sent to the plotter by the computer, it is stored in the buffer and simultaneously acted on by the plotter. The preceding figure is representative of the way the Xon-Xoff handshake works; the numbers represent the following:

1. Data enters the buffer faster than it can be acted on by the plotter, and the buffer starts to fill.
2. The plotter begins processing the input data faster than the computer sends it, and the buffer starts to empty.
3. The data enters the buffer at a faster rate than the plotter can process it. The amount of data stored in the buffer reaches the Xoff threshold level, at which point the plotter sends the Xoff trigger character stopping the flow of data from the computer.
4. Due to a finite delay between the time the plotter sends the Xoff trigger character and the time it takes the computer to react, a slight overshoot may occur. For this reason, the Xoff threshold level should always be specified at least as large as the data block size or the

maximum number of bytes sent by an output statement to allow room for the overshoot.

5. Once the Xoff trigger character has been sent, when the amount of stored data drops to the Xon threshold level, the plotter sends the Xon trigger character to signal the computer to resume sending data. The Xon threshold level is automatically set at 512 bytes. If the Xoff threshold level is greater than 512, the Xon threshold is reset to send the Xon character when one more byte than required by the Xoff threshold is available in the plotter's buffer.
6. Data is again stored in the buffer until all the data are transferred or until the Xoff threshold level is exceeded again.

The following conditions can be specified for the Xon-Xoff handshake mode to match the requirements of the computer system, by using the appropriate instruction:

- Xoff threshold level (ESC . I instruction)
- Xon trigger character (ESC . I instruction)
- Xoff trigger character (ESC . N instruction)
- Intercharacter delay (ESC . N instruction)

The enquiry character (ESC . I instruction) must either be defaulted or specified as zero.

Enquire/Acknowledge Handshake

With the enquire/acknowledge handshake, the computer's operating system or application program initiates the data exchange process by querying the plotter about the availability of buffer space. The format of the exchange is dependent upon the requirements of the computer. The following conditions can be specified for the enquire/acknowledge handshake mode by using the appropriate instruction:

- Turnaround delay (ESC . M instruction)
- Output trigger character (ESC . M instruction)
- Echo terminate character (ESC . M instruction)
- Output initiator character (ESC . M instruction)
- Output terminator (ESC . M instruction)
- Intercharacter delay (ESC . N instruction)
- Immediate response string (ESC . N instruction)
- Data block size (ESC . I or ESC . H instruction)

- Enquiry character (ESC . I or ESC . H instruction)
- Acknowledgment string (ESC . I or ESC . H instruction)

In its simplest form, the data exchange looks like this:

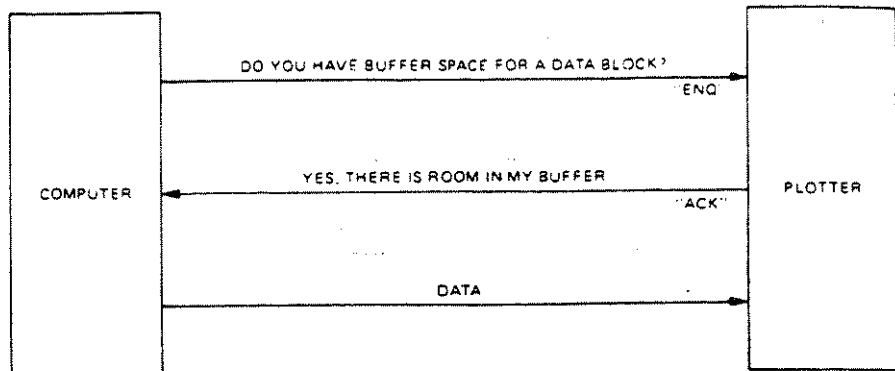

ENQ/ACK Handshake Protocol Example 1

In a more complex form, the communication might look like the following example, where the two instructions **ESC** . M250;17;10;13: and **ESC** . H100;5;6: have been sent to specify the variables as:

turnaround delay = 250 ms

output trigger character = ASCII character DC1 (decimal equivalent 17)

echo terminate character = ASCII character LF (decimal equivalent 10)

output terminator = ASCII character CR (decimal equivalent 13)

data block size = 100 bytes

enquiry character = ASCII character ENQ (decimal equivalent 5)

acknowledgment string = ASCII character ACK (decimal equivalent 6)

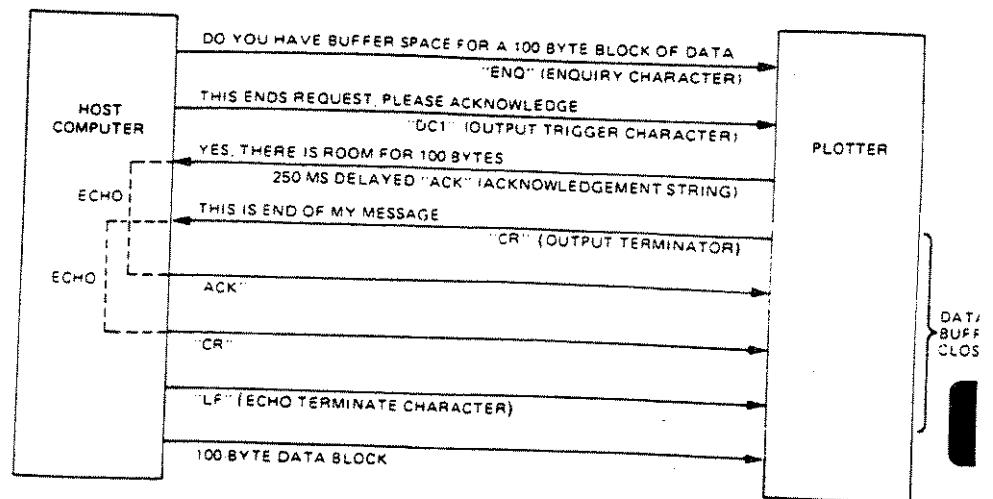

ENQ/ACK Handshake Protocol Example 2

Hardware Handshake

As the name implies, the hardware handshake takes place in the hardware rather than the firmware or software. The plotter controls the data exchange sequence by setting the electrical voltage on pin 20 of the connector (CD line) to the computer to signal the computer when to send another block of data. If there is enough room in the plotter's buffer to accept and store another block of data, the plotter sets the Data Terminal Ready, CD, line to a high state. If there is insufficient space, it sets the line low. By monitoring this line, the computer knows when it can or cannot safely transmit another block of data.

The hardware handshake mode is enabled at power on or by setting the Data Terminal Ready, CD, line control using the ESC . @ instruction.

Data Transmission Modes

The RS-232-C version of the 7475 has two modes of data transmission: normal mode and block mode.

Normal Mode

In normal mode, all HP-GI instructions are put in an execution buffer where they are parsed and executed in order. Escape sequence instructions (ESC . E, ESC . B, ESC . M, etc.) are not buffered but are executed immediately.

Block Mode

In block mode, all characters received are put in an intermediate buffer except for escape sequence instructions and handshake characters. Escape sequence instructions are still executed immediately.

The size of a block is variable and is not defined explicitly. A new block is started after an ESC . E instruction has been received. A block of instructions is terminated by the receipt of another ESC . E instruction which outputs the current RS-232-C error state. Refer to the ESC . E instruction for additional information.

Block mode has no effect on the type of handshaking used or on the handshaking parameters that are defined. The number of characters in the intermediate buffer plus the number of characters in the execution buffer cannot exceed a total of 1024 characters.

Access block mode by setting bit 4 in the second parameter of the ESC . @ instruction. Set this bit to 0 for normal mode and to 1 for block mode. Refer to the discussion of the ESC . @ instruction for additional information. Use block mode to catch transmission errors that have reached the plotter. This allows you to retransmit the correct block of data, and thus prevent errors to the plot.

When the 7475 powers up, it is in normal mode. When block mode is turned on, any characters in the buffer are put in the execution buffer. When block mode is turned off, the state of the intermediate buffer is undefined. Before turning off block mode, send an ESC . E instruction to clear out the intermediate buffer.

NOTE: It is not advisable to use the ESC . L instruction when in block mode as it may disrupt communication. If you use an ESC . L instruction while in block mode, use it immediately after an ESC . E instruction. Send the ESC . E instruction, read the response, send the ESC . L instruction, read the response, and then send the additional HP-GL instructions. ■

RS-232-C Device Control Instructions

Device control instructions establish the handshake protocol to be used by the 7475 plotter. All communications conform to the protocol established by these instructions. The instructions serve two purposes: to control the method by which data is transferred between the computer and the plotter (input/output operations), and to give the computer the ability to query and to receive information from the plotter.

Each instruction's name gives an immediate clue to its purpose: if "output" is the first word in the name of the instruction, the computer wants a response from the plotter. Otherwise, the instruction concerns the I/O functions. The word "set" in the title indicates the instruction conditions under which subsequent I/O is to occur.

The plotter acts on device control instructions immediately upon receipt. It does not store them in the data buffer.

Syntax for Device Control Instructions

Device control instructions are three-character escape code sequences comprised of "ESC" and "." followed by one of the characters @, B, E, H, I, J, K, L, M, N, or O, R,), (, Y, or Z.

These syntax conventions are used with the instructions discussed in this chapter:

| | |
|-------|---|
| [] | Brackets indicate that all parameters enclosed are optional. |
| () | Parentheses indicate that each individual parameter is optional. |
| ; | The semicolon follows and delimits parameters. If a semicolon appears without a parameter, the parameter is defaulted. |
| : | The colon terminates any instruction which may have parameters and can occur after any valid number of parameter entries. Any parameter that is not specified is defaulted. |
| <DEC> | This symbol specifies a decimal value parameter. For example, the characters 10 would represent the decimal value ten; the characters 13 would represent the decimal value thirteen. |
| <ASC> | This symbol specifies the decimal equivalent for an ASCII character (see the ASCII Character Equivalents table in Appendix C). In this case, the characters 10 would represent the ASCII line feed character, LF, and 13 would represent the ASCII carriage return character, CR. |
| ... | Specifies a number of optional parameters. Each parameter must be followed by a delimiter (;) or the terminator (:). |
| TERM | Unless changed by an ESC . M instruction, all RS-232-C output responses include a CR as a terminator. |

Default Values;
Omitting Parameters

Any parameter may be omitted or, if the parameter is required, it can be set to its default value by omitting the parameter and entering only the semicolon as a delimiter. All parameters may be omitted and therefore set to default values by entering only the colon terminator after the instruction.

ESC

Denotes the single ASCII character, Escape, which in most computers is accessed by striking a single key on the keyboard.

NOTE: There is no delimiter (semicolon) between the three-character command sequence, e.g., **ESC** . O, and the first parameter. ■

The Plotter On Instruction, ESC . (or ESC . Y

DESCRIPTION The plotter on instruction, ESC . (or ESC . Y, places a plotter which is powered on into the on-line, programmed-on mode so that it will accept incoming data and interpret it as plotter instructions.

USES This instruction is used when the rear-panel switch labeled \forall/D is set to \forall to ready the plotter to accept other instructions. It is sent at the beginning of any plotting program or when the user wishes to resume plotting after the plotter has been turned off by an ESC .) or ESC . Z instruction or a Break.

SYNTAX **ESC** . (

or

ESC . Y

EXPLANATION This instruction is ignored when the rear-panel switch labeled \forall/D is set to D since, in that case, turning on the power places the plotter in the programmed-on state.

Beginning with the next character, the plotter will accept incoming data and interpret it as plotter instructions. If the plotter is already in the programmed-on state, it will ignore this instruction.

The Plotter Off Instruction, ESC .) or ESC . Z

DESCRIPTION The plotter off instruction, ESC .) or ESC . Z, takes the plotter out of on-line, programmed-on state so that it neither accepts nor interprets incoming data until another plotter on instruction is received.

USES The instruction is used to deactivate the plotter. It is used at the end of a graphics program or in some environments to allow data to be passed through the plotter to the terminal.

SYNTAX **ESC** .)
or
ESC . Z

EXPLANATION This instruction is ignored when the rear-panel switch labeled Y/D is set to D. When that switch is set to D, it is not possible to turn the plotter off programmatically.

Beginning with the next character, the plotter will assume a passive state and remain in that state until a plotter on instruction is received.

Any HP-GL instructions remaining in the buffer at the time that a plotter off instruction is received are executed. However, no additional HP-GL instructions will be accepted by the plotter.

NOTE: A Break signal from the terminal will have the same effect as a plotter off instruction. ■

The Set Plotter Configuration Instruction, **ESC** . @

DESCRIPTION The set plotter configuration instruction, **ESC** . @, specifies an effective maximum buffer size, and sets parameters necessary for hardwire handshake mode, monitor mode, and Data Transmission Mode.

USES The instruction is used to set up an effective maximum buffer size, to enable or disable hardwire handshake or monitor mode, and to establish Data Transmission Mode.

SYNTAX **ESC** . @ [(<DEC>); (<DEC>)]:

DEFAULT **ESC** . @: Sets up default buffer size (1024 characters), enables hardwire handshake, disables monitor mode, and leaves the Data Transmission Mode unchanged.

EXPLANATION A description of the instruction's parameters follows:

<DEC> The first parameter is not required; if a parameter is included, it specifies an effective maximum buffer size. Parameter range is 0 to 9999. A parameter equal to or greater than 1024 is interpreted as 1024. The semicolon must precede any second parameter.

<DEC> Only bits 0, 2, 3, and 4 are used. Bit 0 of the second parameter establishes hardwire handshake with Data Terminal Ready, CD, line control. Bit 2 establishes the

type of monitor mode. Bit 3 set to 0 disables monitor mode; set to 1 enables the monitor mode established by bit 2. Block mode is enabled by setting bit 4 in the second parameter to 1. Setting bit 4 to 0 enables normal mode. Refer to the discussion of block mode in this chapter for additional information. If the second parameter is not specified, the Data Transmission Mode is unchanged.

The following chart describes the second parameter bit functions.

| Bit No. | Logic State | Description |
|---------|-------------|--|
| 0 | 0 | Set and hold line high (disable hardware handshake). |
| | 1 | Enable hardware handshake mode.* |
| 1 | X | Ignored. |
| 2 | 0 | Establish monitor mode 0 (all bytes displayed on terminal as they are parsed from the buffer). |
| | 1 | Establish monitor mode 1 (all bytes displayed as they are received). |
| 3 | 0 | Disable monitor mode. |
| | 1 | Enable the monitor mode established by bit 2. |
| 4 | 0 | Enable normal mode. |
| | 1 | Enable block mode. |

*When hardware handshake is enabled, the DTR line becomes a "buffer space available" flag. The line is high when available buffer space is greater than or equal to the current block size, and is held low when available buffer space is less than the current block size. This size defaults to 80 bytes unless a different value is specified by the ESC . H or ESC . I instruction.

EXAMPLE ESC . @ ; 13 : will establish monitor mode 1 where all bytes are displayed on the terminal as they are received by the plotter.

The Output Buffer Space Instruction, ESC . B

DESCRIPTION The output buffer space instruction, ESC . B, outputs the plotter's available buffer space.

USES This instruction is used in a software checking handshake to interrogate the plotter regarding available buffer space.

SYNTAX ESC . B

EXPLANATION No parameters are used.

RESPONSE

<DEC> The plotter's response is a decimal number in the range 0 to 1024, and represents the number of bytes of buffer space currently available for storing graphic instructions sent from the computer.

TERM This decimal number is followed by the output terminator which defaults to carriage return, CR, or is as set by ESC . M.

The Output Extended Error Instruction, ESC . E

DESCRIPTION The output extended error instruction, ESC . E, outputs a number which defines any RS-232-C related I/O error and turns off the front-panel ERROR light, if no HP-GL instruction errors are present.

USES The instruction is used to define what type of RS-232-C related I/O error has occurred, if any.

SYNTAX ESC . E

EXPLANATION No parameters are used.

RESPONSE

<DEC> The plotter's response is a decimal number, either 0 or in the range 10-16, followed by the output terminator. The meaning of the response is as defined in the following table.

| Error No. | Meaning |
|-----------|--|
| 0 | No I/O error has occurred |
| 10 | Output instruction received while another output instruction is executing. The original instruction will continue normally; the one in error will be ignored. |
| 11 | Invalid byte received after first two characters, ESC ., in a device control instruction. |
| 12 | Invalid byte received while parsing a device control instruction. The parameter containing the invalid byte and all following parameters are defaulted. |
| 13 | Parameter out of range. |
| 14 | Too many parameters received. Additional parameters beyond the proper number are ignored; parsing of the instruction ends when a colon (normal exit) or the first byte of another instruction is received (abnormal exit). |
| 15 | A framing error, parity error, or overrun error has been detected. |
| 16 | The input buffer has overflowed. As a result, one or more bytes of data have been lost, and therefore an HP-GL error will probably occur. |

NOTE: The receipt of something other than another parameter, a semicolon, or a colon will result in error 12 overwriting error 14. ■

TERM The terminator defaults to carriage return, CR, unless it is set by an ESC . M.

To check for transmission errors in a data block, first enter block mode by setting bit 4 of the second parameter of the ESC . @ instruction to logic state 1 (decimal value 16). Then begin sending data blocks, following each with the ESC . E instruction.

In block mode, there are two possible types of response to the ESC . E instruction. If the response to the ESC . E instruction is zero, then there have been no transmission errors since the last ESC . E. In this case, the block of HP-GL instructions is transferred to the execution buffer and the instructions are executed in order. If the error number in response to the ESC . E instruction is 10-16, then there has been a transmission error since the last ESC . E. In this case, the block of

The Set Handshake Mode 1 Instruction, ESC . H

DESCRIPTION The set handshake mode 1 instruction, ESC . H, may be used with the enquire/acknowledge or Xon-Xoff handshake to establish parameters for the plotter's communication format.

USES It establishes the data block size, the enquiry character, and the acknowledgment string when the computer requires that the parameters set in the ESC . M instruction be used in response to the enquiry character or Xon character.

SYNTAX ESC . H [(<DEC>); (<ASC>); (<ASC>(; ... <ASC>))]:

DEFAULT ESC . H: See ESC . I default.

EXPLANATION The two instructions, ESC . H and ESC . I, are mutually exclusive. The parameter descriptions are the same for both instructions and are given under the ESC . I instruction.

Handshake mode 1, established by this instruction, uses defaulted or specified parameters of the ESC . M and ESC . N instructions when responding to the enquiry or Xon trigger character.

The parameters used with handshake mode 1, handshake mode 2, and output responses are shown in the following table. Choose the mode and use handshake mode 1 (ESC . H) or handshake mode 2 (ESC . I) depending on the requirements of your system.

Parameter Usage in Plotter/Computer Communication

| Parameter | With Handshake Characters | | With Plotter Output Instructions |
|--------------------------|---------------------------|-----------|----------------------------------|
| | In Mode 1 | In Mode 2 | |
| turnaround delay | yes | yes | yes |
| output trigger character | yes | no | yes |
| echo terminator | yes | no | yes |
| output terminator | yes | no | yes |
| output initiator* | no | no | yes |
| intercharacter delay | yes | yes | yes |

*If an output initiator is required on enquiry character responses, it should be specified as the first character of the acknowledgment string and/or the immediate response string, depending on the system.

EXAMPLES See ESC . I and ESC . N.

The Set Handshake Mode 2 Instruction, ESC . I

DESCRIPTION The set handshake mode 2 instruction, ESC . I, may be used with the enquire/acknowledge or Xon-Xoff handshake to establish parameters for the plotter's communication format.

USES It establishes the data block size, the enquiry character, and the acknowledgment string for the enquire/acknowledge handshake when the computer expects only the turnaround delay, and not the other parameters set by ESC . M, to be included in the response to the enquiry character. It sets the Xoff threshold level and the Xon trigger character for Xon-Xoff handshake.

SYNTAX ESC . I [(<DEC>); (<ASC>); (<ASC>(; ... <ASC>))]:

DEFAULT ESC . I: (or ESC . H:) Neither Xon-Xoff nor enquire/acknowledge handshake is enabled. Block size is 80 bytes, and there is no enquiry character or acknowledgment string. If, however, the computer is configured to send an ENQ anytime it is ready to send data to

the plotter, the plotter will automatically respond with ACK when it receives ENQ. This "dummy handshake" is not dependent upon available buffer space and does not protect against buffer overflow.

EXPLANATION The two instructions, ESC . I and ESC . H, are mutually exclusive. With handshake mode 2, the only parameter of the ESC . M instruction used when responding to the enquiry or Xon trigger character is the turnaround delay. Refer to the chart under the ESC . H instruction to see which parameters are used in various plotter output situations. Choose your mode using ESC . I or ESC . H, depending on the requirements of your system.

The parameters for both ESC . H and ESC . I are the same and are described below, first as interpreted for the enquire/acknowledge handshake and then as interpreted for the Xon-Xoff handshake.

For Enquire/Acknowledge Handshake

<DEC> This first parameter specifies the **block size**; its range is 0 to 9999. A parameter equal to or greater than 1024 is interpreted as 1024. Default block size set when the parameter is omitted is 80 bytes.

<ASC> This parameter sets the **enquiry character**. The parameter may be the decimal equivalent of any ASCII character in the range 0 to 127. If the parameter is omitted, it assumes the default value 0 (NULL character) disabling enquire/acknowledge handshake. Any value other than 0 enables enquire/acknowledge handshake. However, the value 5 (enquire character, ENQ) is generally used.

<ASC> ... <ASC> This is a list of 1 to 10 parameters, separated by semicolons, which specify the **acknowledgment string**. Decimal equivalents of ASCII characters 0 to 127 are valid. The value 0 is not transmitted and will terminate the string. The value 6 (acknowledge character, ACK) is generally used. If the parameter is omitted, it assumes its default value and no characters are sent.

For Xon-Xoff Handshake

<DEC> This first parameter sets the **Xoff threshold level** by specifying the number of empty bytes remaining in the buffer when the Xoff character is to be sent. The practical range is 10 to 1023. If the Xoff parameter is specified to be greater than 512 (half the buffer size), the Xon threshold level will be reset (from its automatic setting of half the buffer size) so that the Xon character will be sent when one byte more than the Xoff level is available.

<ASC> This parameter should be omitted by entering only the semicolon or the value 0 followed by the semicolon. To enable Xon-Xoff handshake, the next parameter, which specifies an Xon trigger character(s), must be included.

<ASC>...<ASC> This is a list of from 1 to 10 parameters, separated by semicolons, which specify the Xon trigger character(s). Decimal equivalents of ASCII characters 0 to 127 are valid. The value 0 is not transmitted and will terminate the string.

EXAMPLES See also the ESC . N instruction.

For Enquire/Acknowledge Handshake

ESC . H 132;19;20;7: will set the block size to 132 bytes, the ASCII character DC3 as the enquiry character, and the two characters, DC4 and Bell, as the acknowledgment string. Since ESC . H sets handshake mode 1, the currently defined output initiator, output terminator, output trigger character, and echo terminator, as well as both turnaround delay and intercharacter delay, are used when the response string, DC4 Bell, is sent.

ESC . I 5;6: will set the block size to its default value of 80 bytes, the ASCII character ENQ as the enquiry character, and the single ASCII character ACK as the acknowledgment string. Only the turnaround delay, intercharacter delay, and immediate response string, if any, are used when sending the response. No output initiator will precede it, even if one is defined, and no output terminator will follow it.

For Xon-Xoff Handshake

ESC . I 81;;17: will set the Xoff threshold level to 81 (the Xoff character will be sent when 81 empty bytes remain in the plotter's buffer) and set the Xon trigger character to DC1. The second parameter is defaulted as required for this handshake. The Xoff trigger character must be set using the ESC . N instruction. Transmittal of the Xon and Xoff trigger characters is subject only to turnaround and intercharacter delays, if any are specified. No output initiator will precede them, even if one is defined, and no output terminator will follow them.

The Abort Device Control Instruction, ESC . J

DESCRIPTION The abort device control instruction, ESC . J, aborts any device control instruction that may be partially decoded or executed.

USES This instruction may be used in an initialization sequence when you first access the plotter.

SYNTAX ESC . J

EXPLANATION This instruction aborts any single device control instruction that may be partially decoded or executed. Unspecified parameters of aborted instructions are defaulted. All pending or partially transmitted output requests, from either HP-GL or device control instructions, are immediately terminated, including output responses and handshake parameters. Intermediate output operations such as turnaround delay and echo suppression are aborted, and the buffer input is enabled. The handshake and output mode parameters remain as specified.

The Abort Graphic Instruction, ESC . K

DESCRIPTION The abort graphic instruction, ESC . K, aborts any partially decoded HP-GL instruction and discards instructions in the buffer.

USES The instruction can be used as part of an initialization sequence when starting a new program or to terminate plotting of HP-GL instructions in the buffer.

SYNTAX ESC . K

EXPLANATION Any partially decoded HP-GL instruction is aborted and all instructions in the buffer are discarded. A partially executed instruction is allowed to finish.

The Output Buffer Size Instruction, ESC . L

DESCRIPTION The output buffer size instruction, ESC . L, outputs the size, in bytes, of the plotter's buffer.

USES The instruction is used to obtain information on the size of the plotter's buffer. This information might be used to determine parameters of instructions which set up handshaking.

SYNTAX ESC . L

EXPLANATION No parameters are used. The instruction causes the 7475 to output, in ASCII, a decimal number equal to the number of bytes in the plotter's buffer.

RESPONSE

<DEC> 1024

TERM Defaults to carriage return, CR, or is as set by ESC . M.

NOTE: It is not advisable to use the ESC . L instruction when in block mode as it may disrupt communication. If you use an ESC . L instruction while in block mode, use it immediately after an ESC . E instruction.

Send the ESC . E instruction, read the response, send the ESC . L instruction, read the response, and then send the additional HP-GL instructions. ■

The Set Output Mode Instruction, ESC . M

DESCRIPTION The set output mode instruction, ESC . M, establishes parameters for the plotter's communication format.

USES The instruction is used to establish a turnaround delay, an output trigger character, an echo terminate character, and an output initiator character. It is also used to change the output terminator from its default value, carriage return.

SYNTAX ESC . M[(**<DEC>**);(**<ASC>**);(**<ASC>**);(**<ASC>**);(**<ASC>**)];(**<ASC>**)

DEFAULT ESC . M: Sets the carriage return character (decimal equivalent 13) as the output terminator. It also specifies that there is no turnaround delay and no output trigger, echo terminate, or output initiator character.

EXPLANATION A colon must be used following the last parameter (if any). Use of the instruction without parameters is equivalent to ESC . M: (see DEFAULT).

A description of the instruction's parameters follows.

- <DEC>** The first parameter is optional. If present, it is the **turnaround delay**. The delay implemented is $((\text{parameter} \times 1.1875) \bmod 65536) / 1.2$ milliseconds. The parameter range is 0 to 54612 milliseconds. If parameters follow, the semicolon must be included even if this decimal parameter is omitted.
- <ASC>** The second parameter is also optional and, if omitted, assumes its default value of 0 (no trigger character). If included, it specifies a single character which becomes the **output trigger character**. The parameter may be the decimal equivalent of any ASCII character in the range 0 to 127. If parameters follow, the semicolon must always be included, even when this parameter is omitted.
- <ASC>** The third parameter is optional and, if omitted, assumes its default value 0 (no echo terminate character). If included, it specifies a single character which becomes the **echo terminate character**. The parameter may be the decimal equivalent of any ASCII character in the range 0 to 127. If parameters follow, the semicolon must always be included, even when this parameter is omitted.

<ASC> ... <ASC> The fourth parameter is optional and defaults to 13, the decimal equivalent of the single ASCII character, carriage return.

If included, the parameter may be the decimal equivalent(s) of one or two ASCII characters in the range 0 to 127. This becomes the **output terminator**. The value 0 is not transmitted and will terminate the string. If a parameter follows, the semicolon must always be included, even when this parameter is omitted. If the fifth parameter is specified, this fourth parameter must consist of two characters, or the second character must be specified as null using the semicolon.

<ASC> The fifth parameter is optional and, if omitted, assumes its default value 0 (no output initiator character). If included, it is the decimal equivalent of a single character which becomes the **output initiator** character. The parameter may be the decimal equivalent of any ASCII character in the range 0 to 127. The parameter is followed by a colon.

EXAMPLES See the ESC . N instruction.

The flowchart on the next page depicts plotter output.

The Set Extended Output and Handshake Mode Instruction, ESC . N

DESCRIPTION The set extended output and handshake mode instruction, ESC . N, establishes parameters for the plotter's communication format.

USES The instruction is used to specify an intercharacter delay in all handshake modes, the immediate response string for enquire/acknowledge handshake, or the Xoff trigger character(s) for the Xon-Xoff handshake.

SYNTAX ESC . N | (<DEC>); (<ASC>; ... <ASC>)|:

DEFAULT ESC . N: No intercharacter delay and no Xoff trigger character or immediate response string.

EXPLANATION A colon must be used following the last parameter. Use of the instruction without parameters is equivalent to ESC . N: (see DEFAULT).

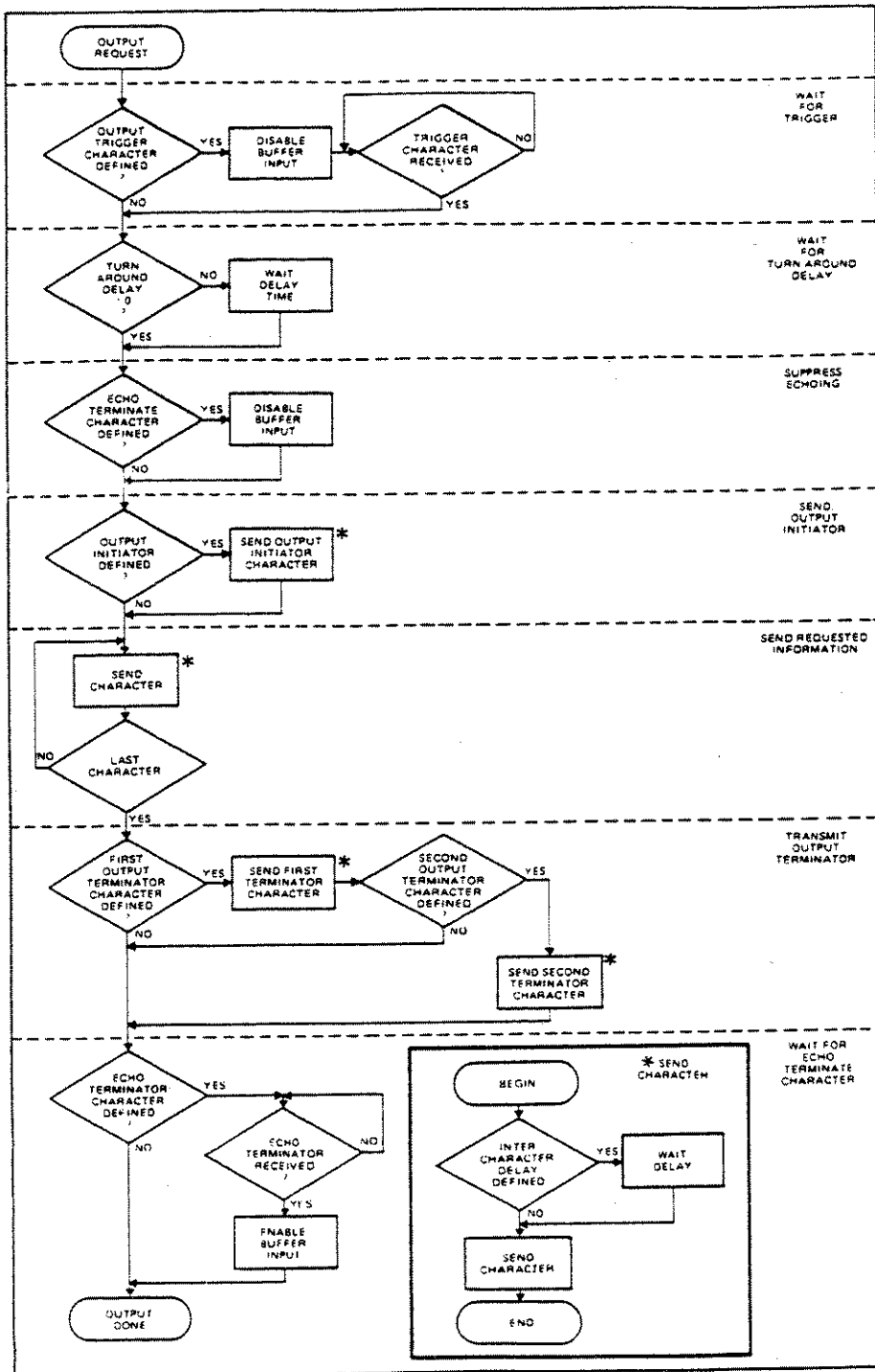

Output Request Flow Chart

A description of the instruction's parameters follows:

<DEC> The first parameter is optional. If present, it is the **intercharacter delay**. The delay implemented is $((\text{parameter} \times 1.1875) \bmod 65536) / 1.2$ milliseconds. The parameter range is 0 to 54612 milliseconds. If parameters follow, the semicolon must be included, even if this decimal parameter is omitted.

<ASC>...<ASC> This parameter is optional. If present, it is a list of the decimal equivalents of 1 to 10 ASCII characters in the range 0 to 127. For **Xon-Xoff handshake mode**, it specifies the **Xoff trigger character(s)**. For **enquire/acknowledge handshake mode**, it specifies the **immediate response string**. Semicolons must separate each parameter in the list.

EXAMPLES

For Xon-Xoff Handshake

ESC . N;19: Sets the Xoff trigger character to DC3. There will be no intercharacter delay, since the first parameter is defaulted to zero by the semicolon.

For Enquire/Acknowledge Handshake

The examples given here include all handshaking instructions. In addition to illustrating the use of intercharacter delays and immediate response strings set by **ESC . N**, they are designed to clarify the difference between handshake mode 1 and mode 2 and give some insight into why certain values are logical choices for some parameters. The first BASIC program can be used as a handshake for the Apple II Plus computer with the A2B0005 serial interface card installed in slot #1 and baud rate set at 2400. Note the **CHR\$** function is used to send the escape character.

```
10 DIM OUT$(80)
20 IN#1
30 PR#1
40 PRINT CHR$(27);".M0;63;0;13:";CHR$(27);".N5:"
50 PRINT CHR$(27);".H80;18;49:"
60 OUT$="IN;SP1;PA500,500;":GOSUB 100
:
:
100 PRINT CHR$(18): INPUT Z: PRINT OUT$: RETURN
```

The following parameters are set in lines 40 and 50:

- turnaround delay = 0,
- output trigger character = ? (decimal equivalent 63),
- no echo terminate character,

output terminator = carriage return (decimal equivalent 13),
intercharacter delay = 5,
no immediate response string,
block size = 80,
enquiry character = DC2 (decimal equivalent 18), and
acknowledgment string = 1 (decimal equivalent 49).

The subroutine in line 100 controls the handshaking. It causes the following chronological action. The enquiry character, DC2, is sent asking if the plotter has room for an 80-byte block. The plotter does not send an immediate response because that has been specified as null by its omission in the ESC . N instruction. The plotter holds its response until after it receives the output trigger character, ?. The question mark is sent by the computer when it interprets the BASIC statement INPUT to prompt for the input, Z. Z is the variable into which the acknowledgment string, 1, is read. If the acknowledgment string had been specified to contain nonnumeric characters, a string variable such as Z\$ would have been used instead of Z.

The plotter waits approximately five milliseconds, the intercharacter delay, before sending the 1 and between the 1 and the output terminator, carriage return. Note the carriage return parameter could have been omitted, but carriage return still would have been sent as the output terminator because that is the default value for output terminator. If ESC . I had been used instead of ESC . H, the output terminator would not have been sent after the acknowledgment string (but it would follow responses to HP-GL output instructions). The carriage return character is a logical choice, because it is expected by the computer to delineate the end of data read by the INPUT statement.

The computer is now free to send the string OUT\$, which contains HP-GL instructions, to the plotter. Note the enquiry character must be sent each time data is sent to the plotter.

Another handshake which would work using ESC . I is

```
40 PRINT CHR$(27);".I80;7;33;13:"  
50 PRINT CHR$(27);".M500:";CHR$(27);".N5:"  
.  
.  
100 PRINT CHR$(7):INPUT Z$: PRINT OUT$: RETURN
```

The following parameters are established:

turnaround delay = 500,
no output trigger character,
no echo terminate character,
output terminator = default value, carriage return,
intercharacter delay = 5,
no immediate response string,
block size = 80,
enquiry character = bell (decimal equivalent 7), and
acknowledgment string = ! carriage return (decimal equivalent 33,
13)

Now the computer sends the Bell character as the enquiry character. The plotter waits approximately 505 milliseconds, the total of the turnaround delay and the intercharacter delay, before sending its response. During that time, the computer will send the ? due to the INPUT statement, but the plotter ignores it. The plotter response to the enquiry character is now two characters, ! followed by a carriage return. The carriage return to terminate INPUT is now part of the acknowledgment string. No output terminator, now defaulted to carriage return, is sent because handshake mode 2 is set here by ESC . I. The output terminator, carriage return, will still follow all responses to HP-GL output instructions.

The Output Extended Status Instruction, ESC . O

DESCRIPTION The output extended status instruction, ESC . O, outputs the plotter's extended status, giving information about the state of the buffer, pinch wheels, and VIEW button.

USES The instruction can be used to determine, from a remote location, if the plotter is ready to plot.

SYNTAX ESC . O

EXPLANATION No parameters are used. Unlike the HP-GL output status instruction, OS, the ESC . O instruction does not enter the buffer but is executed immediately, subject to any turnaround or intercharacter delays specified by ESC . M and ESC . N.

RESPONSE

<DEC>

The response is the decimal equivalent of a 6-bit immediate status word, followed by the output terminator. The maximum value output is 40.

The extended status word bits are as defined in the following table.

| Bit | State | Decimal Value | Meaning |
|------|-------|---------------|---|
| 0-2 | 0 | 0 | Not used, always zeros. Reserved for plotters with paper advance. |
| 3 | 0 | 0 | Buffer is not empty. |
| | 1 | 8 | Buffer is empty and ready for data. |
| 4, 5 | 00 | 0 | Ready to process or processing HP-GL instructions. |
| | 01 | 16 | Paper loaded, VIEW button pressed so graphics suspended. |
| | 10 | 32 | Paper lever raised so graphics suspended. |

Combinations of these bits allow five different responses to the ESC . O instruction.

| Response | Meaning |
|----------|--|
| 0 | Buffer is not empty and plotter is processing HP-GL instructions. |
| 8 | Buffer is empty and is ready to process or is processing HP-GL instructions. |
| 16 | Buffer is not empty and VIEW has been pressed. |
| 24 | Buffer is empty and VIEW has been pressed. |
| 32 | Buffer is not empty and paper lever and pinch wheels are raised. |
| 40 | Buffer is empty and paper lever and pinch wheels are raised. |

TERM

The output terminator defaults to carriage return unless it is set by ESC . M.

The Reset Handshake Instruction, ESC . R

DESCRIPTION The reset handshake instruction, ESC . R, resets all handshake parameters to their default values.

USES The instruction may be used to set the plotter's handshake responses to a known state with hardwire handshake enabled.

SYNTAX ESC . R

EXPLANATION Executing this instruction is the same as executing the following instructions without parameters: ESC . @, ESC . H, ESC . I, ESC . M, and ESC . N. Executing this instruction, however, does not reset the HP-GL graphic instructions that may have already been sent.

The following table shows the default values of parameters used to establish handshakes.

| Parameter | Value |
|-----------------------------|-----------------------------------|
| block size | 80 |
| enquiry character | 0 — no handshake enable character |
| acknowledgment string | 0 — no handshake response string |
| turnaround delay | 0 |
| output trigger character | 0 — no trigger character |
| echo terminate character | 0 — no echo terminate character |
| output terminator | 13;0; — carriage return |
| output initiator | 0 — no output initiator |
| intercharacter delay | 0 — no delay |
| immediate response string | 0 — no immediate response string |
| monitor mode | disabled |
| hardwire handshake (pin 20) | enabled |
| buffer size | 1024 |
| Xon level | 512 |
| normal data transfer mode | enable |
| block data transfer mode | disable |

Appendix **A**

An HP-IB Overview

The HP Interface Bus (HP-IB) provides an interconnecting channel for data transfer between devices on the HP-IB.

The following list defines the terms and concepts used to describe HP-IB (bus) system operations.

HP-IB System Terms

1. **Addressing** — the characters sent by a controlling device specifying which device sends information on the bus and which device(s) receives the information.
2. **Byte** — a unit of information consisting of 8 binary digits (bits).
3. **Device** — any unit that is compatible with the ANSI/IEEE 488-1978 Standard.
4. **Device Dependent** — a response to information sent on the HP-IB that is characteristic of an individual device's design, and may vary from device to device.
5. **Operator** — the person that operates either the system or any device in the system.
6. **Polling** — the process typically used by a controller to locate a device that needs to interact with the controller. There are two types of polling:
 - **Serial Poll** — a method which obtains one byte of operational information about an individual device in the system. The process must be repeated for each device from which information is desired.
 - **Parallel Poll** — a method for obtaining information about a group of devices simultaneously.

Interface Bus Concepts

Devices which communicate along the interface bus can be classified into three basic categories.

1. **Talkers** — devices which send information on the bus when they have been addressed.

2. **Listeners** — devices which receive information sent on the bus when they have been addressed.
3. **Controllers** — devices that can specify the talker and listeners for an information transfer. Controllers can be categorized as one of two types:
 - **Active Controller** — the current controlling device on the bus. Only one device can be the active controller at any time.
 - **System Controller** — the only controller that can take priority control of the bus if it is not the current active controller. Although each bus system can have only one system controller, the system can have any number of devices capable of being the active controller.

A typical HP-IB system is shown below.

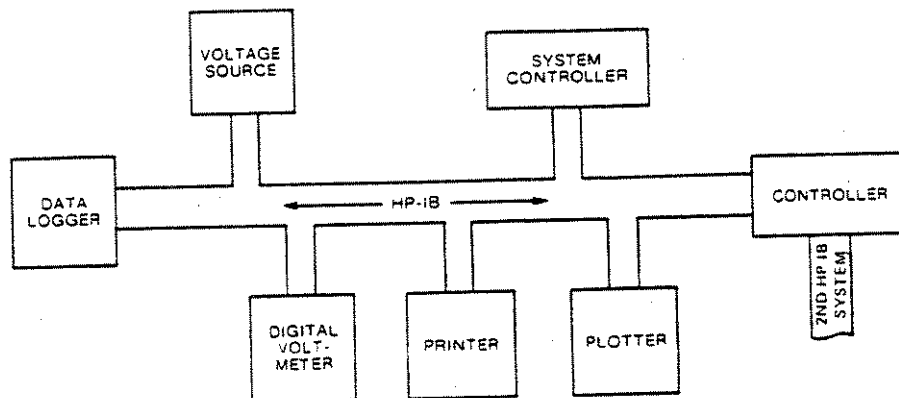

Message Concepts

Devices which communicate along the interface bus are transferring quantities of information. The transfer of information can be from one device to another device, or from one device to more than one device. These quantities of information can easily be thought of as "messages."

In turn, the messages can be classified into 12 types. The list below gives the 12 message types for the HP-IB.

1. **The Data Message.** This is the actual information which is sent from one talker to one or more listeners along the interface bus.
2. **The Trigger Message.** This message causes the listening device(s) to perform a device-dependent action when addressed.
3. **The Clear Message.** This message causes either the listening device(s) or all of the devices on the bus to return to their predefined device-dependent states.

4. **The Remote Message.** This message causes all devices currently addressed to listen to switch from local front-panel control to remote program control.
5. **The Local Message.** This message clears the Remote Message from the listening device(s) and returns the device(s) to local front-panel control.
6. **The Local Lockout Message.** This message prevents a device operator from manually inhibiting remote program control.
7. **The Clear Lockout/Local Message.** This message causes all devices on the bus to be removed from Local Lockout and revert to Local. This message also clears the Remote Message for all devices on the bus.
8. **The Require Service Message.** A device can send this message at any time to signify that the device needs some type of interaction with the controller. This message is cleared by sending the device's Status Byte Message if the device no longer requires service.
9. **The Status Byte Message.** A byte that represents the status of a single device on the bus. Bit 6 indicates whether the device sent a Require Service Message, and the remaining bits indicate operational conditions defined by the device. This byte is sent from a talking device in response to a serial poll operation performed by a controller.
10. **The Status Bit Message.** This byte represents the operational conditions of a group of devices on the bus. Each device responds on a particular bit of the byte thus identifying a device-dependent condition. This bit is typically sent by devices in response to a parallel poll operation.

The Status Bit Message can also be used by a controller to specify the particular bit and logic level at which a device will respond when a parallel poll operation is performed. Thus, more than one device can respond on the same bit.
11. **The Pass Control Message.** This transfers the bus management responsibilities from the active controller to another controller.
12. **The Abort Message.** The system controller sends this message to unconditionally assume control of the bus from the active controller. This message terminates all bus communications (but does not implement a Clear Message).

These messages represent the full implementation of all HP-IB system capabilities. Each device in a system may be designed to use only the messages that are applicable to its purpose in the system. It is

important for you to be aware of the HP-IB functions implemented on each device in your HP-IB system to ensure the operational compatibility of the system.

The HP Interface Bus

HP-IB Lines and Operations

The HP Interface Bus transfers data and commands between the components of an instrumentation system on 16 signal lines. The interface functions for each system component are performed within the component so only passive cabling is needed to connect the systems. The cables connect all instruments, controllers, and other components of the system in parallel to the signal lines.

The eight Data I/O lines (DIO1 through DIO8) are reserved for the transfer of data and other messages in a byte-serial, bit-parallel manner. Data and message transfer is asynchronous, coordinated by the three handshake lines: Data Valid (DAV), Not Ready For Data (NRFD), and Not Data Accepted (NDAC). The other five lines are for management of bus activity. See the figure on the right.

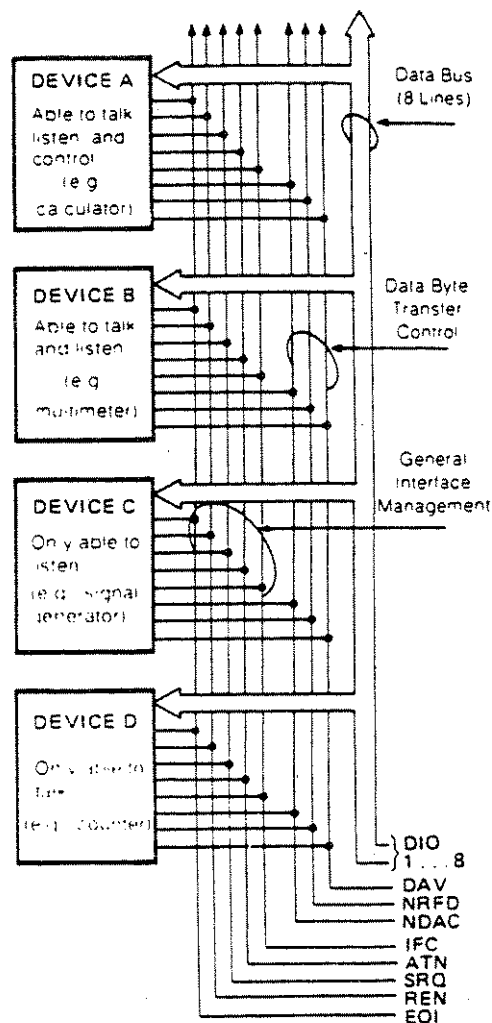

HP-IB Signal Lines

Devices connected to the bus may be talkers, listeners, or controllers. The controller dictates the role of each of the other devices by setting the ATN (attention) line true and sending talk or listen addresses on the data lines. Addresses are set into each device at the time of system configuration either by switches built into the device or by jumpers on

a PC board. While the ATN line is true, all devices must listen to the data lines. When the ATN line is false, only devices that have been addressed will actively send or receive data. All others ignore the data lines.

Several listeners can be active simultaneously but only one talker can be active at a time. Whenever a talk address is put on the data lines (while ATN is true), all other talkers will be automatically unaddressed.

Information is transmitted on the data lines under sequential control of the three handshake lines (DAV, NRFD, and NDAC). No step in the sequence can be initiated until the previous step is completed. Information transfer can proceed as fast as devices can respond, but no faster than allowed by the slowest device presently addressed as active. This permits several devices to receive the same message byte concurrently.

The ATN line is one of the five bus management lines. When ATN is true, addresses and universal commands are transmitted on only seven of the data lines using the ASCII code. When ATN is false, any code of eight bits or less understood by both talker and listener(s) may be used.

The IFC (interface clear) line places the interface system in a known quiescent state.

The REN (remote enable) line is used with the Remote, Local, and Clear Lockout/Set Local messages to select either local or remote control of each device.

Any active device can set the SRQ (service request) line true via the Require Service Message. This indicates to the controller that some device on the bus wants attention, such as a counter that has just completed a time-interval measurement and wants to transmit the reading to a printer.

The EOI (end or identify) line is used by a device to indicate the end of a multiple-byte transfer sequence. When a controller sets both the ATN and EOI lines true, each device capable of a parallel poll indicates its current status on the DIO line assigned to it.

In the interest of cost-effectiveness, it is not necessary for every device to be capable of responding to all the lines. Each can be designed to respond only to those lines that are pertinent to its function on the bus.

The operation of the interface is generally controlled by one device equipped to act as controller. The interface transmits a group of commands to direct the other instruments on the bus in carrying out their functions of talking and listening.

The controller has two ways of sending interface messages. Multi-line messages, which cannot exist concurrently with other multi-line

messages, are sent over the eight data lines and the three handshake lines. Uni-line messages are transferred over the five individual lines of the management bus.

The commands serve several different purposes:

- Addresses or talk and listen commands select the instruments that will transmit and accept data. They are all multi-line messages.
- Universal commands cause every instrument equipped to do so to perform a specific interface operation. They include multi-line messages and three uni-line commands: interface clear (IFC), remote enable (REN), and attention (ATN).
- Addressed commands (also referred to as primary commands) are similar to universal commands, except that they affect only those devices that are addressed and are all multi-line commands. An instrument responds to an addressed command, however, only after an address has already told it to be talker or listener.
- Secondary commands are multi-line messages that are always used in series with an address, universal command, or addressed command to form a longer version of each. Thus they extend the code space when necessary.

To address an instrument, the controller uses seven of the eight data-bus lines. This allows instruments using the ASCII 7-bit code to act as controllers. As shown in the following table, five bits are available for addresses, and a total of 31 allowable addresses are available in one byte. If all secondary commands are used to extend this into a two-byte addressing capability, 961 addresses become available (31 allowable addresses in the second byte for each of the 31 allowable in the first byte.)

Command and Address Codes

| Code Form | | Meaning |
|-----------|--|--------------------|
| X | 0 0 A ₅ A ₄ A ₃ A ₂ A ₁ | Universal Commands |
| X | 0 1 A ₅ A ₄ A ₃ A ₂ A ₁ | Listen Addresses |
| | except | |
| X | 0 1 1 1 1 1 1 | Unlisten Command |
| X | 1 0 A ₅ A ₄ A ₃ A ₂ A ₁ | Talk Address |
| | except | |
| X | 1 0 1 1 1 1 1 | Untalk Command |
| X | 1 1 A ₅ A ₄ A ₃ A ₂ A ₁ | Secondary Commands |
| | except | |
| X | 1 1 1 1 1 1 1 | Ignored |

Code used when attention (ATN) is true (low).
X = don't care.

Interface Functions

Interface functions provide the physical capability to communicate via HP-IB. These functions are defined in the ANSI/IEEE 488-1978 Standard. This standard, which is the designer's guide to the bus, defines each interface function in terms of state diagrams that express all possible interactions.

Bus capability is grouped under 10 interface functions, for example: Talker, Listener, Controller, Remote/Local. The following table lists the functions, including two special cases of Controller.

HP-IB Interface Functions

| Mnemonic | Interface Function Name |
|----------------|--|
| SH | Source Handshake |
| AH | Acceptor Handshake |
| T | Talker (or TE = Extended Talker)* |
| L | Listener (or LE = Extended Listener)* |
| SR | Service Request |
| RL | Remote Local |
| PP | Parallel Poll |
| DC | Device Clear |
| DT | Device Trigger |
| C | Any Controller |
| C _N | A Specific Controller (for example: C _A , C _B ...) |
| C _S | The System Controller |

*Extended Talkers and Listeners use a two-byte address. Otherwise, they are the same as Talker and Listener.

Bus Messages

Since interface functions are the physical agency through which bus messages are implemented, each device must implement one or more functions to enable it to send or receive a given bus message.

The following table lists the functions required to implement each bus message. Each device's operating manual lists the functions implemented by that device. Some devices, such as the 98034A Interface, list the functions implemented directly on the device.

Functions Used by Each Bus Message

| Bus Message | Functions Required sender function – receiver function(s) (support functions) |
|-------------------------|---|
| Data | T – L* (SH, AH) |
| Trigger | C – DT* (L, SH, AH) |
| Clear | C – DC* (L, SH, AH) |
| Remote | C _S – RL* (SH, AH) |
| Local | C – RL* (L, SH, AH) |
| Local Lockout | C – RL* (SH, AH) |
| Clear Lockout/Set Local | C _S – RL* |
| Require Service | SR* – C |
| Status Byte | T – L* (SH, AH) |
| Status Bit | PP* – C |
| Pass Control | C _A – C _B (T, SH, AH) |
| Abort | C _S – T, L*C |

*Since more than one device can receive (or send) this message simultaneously, each device must have the function indicated by an *.

Appendix **B**

Instruction Syntax

HP-GL Syntax

This section lists the formal syntax for each plotter instruction in alphabetical order of the instruction's two-letter mnemonic.

Each instruction is listed with its purpose, syntax, parameter or response type, and range. If no parameter range is given, the range is -2^{15} to $2^{15} - 1$. Refer to the indicated pages for details. The semicolon is included as the terminator for all instructions except the label instructions. The next mnemonic can also be used as the instruction terminator. In addition, if you have an HP-IB plotter, the line feed character can be used as a terminator. TERM means the terminator sent by the plotter at the end of output. It is CRLF in an HP-IB configuration and CR or as set by an ESC.M instruction in an RS-232-C configuration.

Page 3-16

AA The Arc Absolute Instruction

AA X-coordinate, Y-coordinate, arc angle (chord angle);

Purpose: Draws arc of specified number of degrees with specified smoothness; centered at X, Y coordinate, using current pen status (up or down).

Parameters: X- and Y-coordinates — integer, in plotter units unless scaling in effect; then in user units.

arc angle — integer, negative value specifies clockwise arc, positive value specifies counterclockwise arc.

chord angle — integer, defines arc smoothness in degrees. Default is 5 degrees.

AR The Arc Relative Instruction

Page 3-18

AR X-increment, Y-increment, arc angle(, chord angle);

Purpose: Draws arc of specified number of degrees with specified smoothness; centered relative to current pen position, using current pen status (up or down).

Parameters: X- and Y-increments — integer, in plotter units unless scaling in effect; then in user units.

arc angle — integer, negative value specifies clockwise arc, positive value specifies counterclockwise arc.

chord angle — integer, defines arc smoothness in degrees. Default is 5 degrees.

CA The Designate Alternative Character Set Instruction

Page 5-3

CA n;

Purpose: Designates the alternate character set.

Parameter: integer 0-4, 6-9, or 30-39; default set 0.

CI The Circle Instruction

Page 3-11

CI radius(, chord angle);

Purpose: Draws a circle of specified radius centered at current pen position.

Parameters: radius — integer, in plotter units unless scaling in effect; then in user units. Starting point at 0 degrees with positive parameter; 180 degrees with negative parameter.

chord angle — integer, defines circle smoothness in degrees. Default is 5 degrees.

CP The Character Plot Instruction

Page 5-14

CP spaces, lines;

Purpose: Move the pen the number of spaces and lines specified.

Parameters: spaces — decimal, ≥ -128 and < 128 , number of CP spaces, positive value moves pen in current label direction, negative value moves pen in opposite direction.

lines — decimal, ≥ -128 and < 128 , number of CP lines, positive value moves pen up, negative value moves pen down in relation to current label direction.

Omitting parameters causes carriage return, line feed.

CS The Designate Standard Character Set Instruction Page 5-3

CS m ;

Purpose: Designates the standard character set.

Parameter: integer, 0-4, 6-9 or 30-39; default set 0.

DC The Digitize Clear Instruction Page 6-3

DC ;

Purpose: Clears digitize mode without entering a point from the front panel.

DF The Default Instruction Page 1-11

DF ;

Purpose: Returns plotter to default conditions. See the table in Appendix C.

DI The Absolute Direction Instruction Page 5-10

DI run, rise ;

Purpose: Sets the direction of labels.

Parameters: run, rise — decimal values, unitless. At least one must be nonzero, i.e., $|\text{parameter}| \geq 0.0004$.

Omitting parameters causes horizontal labels and is the same as DI 1,0.

DP The Digitize Point Instruction Page 6-2

DP ;

Purpose: Places plotter in digitize mode waiting for point to be entered from front panel.

DR The Relative Direction Instruction Page 5-11

DR run, rise ;

Purpose: Sets the direction of labels.

Parameters: decimals, -128.0000 to +127.9999.

run is % of $(P2_x - P1_x)$, rise is % of $(P2_y - P1_y)$.

Omitting parameters causes horizontal labels as does DR 1,0.

DT The Define Terminator Instruction

Page 5-5

DT t;

Purpose: Defines the label terminator used in LB instruction.

Parameter: ASCII character 1 to 127 except 5 and 27. Only an IN or DF instruction or use of ETX (decimal 3) as parameter restores label terminator to ETX, its default value.

EA The Edge Rectangle Absolute Instruction

Page 3-25

EA X-coordinate, Y-coordinate ;

Purpose: Draws the edge of a rectangle in absolute coordinates.

Parameters: X- and Y-coordinates

Maximum parameters — decimal, -32 768.0000 through 32 767.9999. In plotter units unless scaling in effect; then in user units. When scaling is off, parameters truncated to integers.

ER The Edge Rectangle Relative Instruction

Page 3-28

ER X-increment, Y-increment ;

Purpose: Draws the edge of a rectangle using relative coordinates.

Parameters: X-increment, Y-increment ;

Maximum parameters — decimal, -32 768.0000 through 32 767.9999. In plotter units unless scaling in effect; then in user units. When scaling is off, parameters truncated to integers.

EW The Edge Wedge Instruction

Page 3-34

EW radius, start angle, sweep angle(,chord angle) ;

Purpose: Draws the edge of a wedge.

Parameters:

| Parameter | Type | Range | Default |
|-------------|---------------------|-------------------------------|---------|
| radius | integer/ decimal | -32 768.0000- +32 767.9999 | none |
| start angle | integer | MOD 360 | none |
| sweep angle | integer | -32 768- +32 767 | none |
| chord angle | integer | 1-120 | 5° |

radius — in plotter units unless scaling in effect; then in X-axis user units. The sign of the radius defines the zero-degree reference point for the start angle and sweep angle.

start angle — a positive start angle positions the radius CCW from the zero-degree reference point; a negative start angle positions the radius CW from the zero-degree reference point.

sweep angle — a positive sweep angle draws the arc segment CCW; a negative sweep angle draws the arc segment CW.

FT The Fill Type Instruction

Page 3-21

FT (type(,spacing(,angle)));

or

FT ;

Purpose: Selects a type of area fill for use with an RA, RR, or WG instruction.

Parameters:

| Parameter | Number Type | Range | Default |
|-----------|-------------|-------------------------------------|---|
| fill type | integer | 1-5 | 1 |
| spacing | decimal | 0-32 767.9999 (current units) | 1% of the diagonal distance between P1 and P2 |
| angle | integer | ±45° increments from 0° | 0° |

A 0-degree angle will produce horizontal lines, a 90-degree angle will produce vertical lines, and a 45-degree angle will produce angular lines.

IM The Input Mask Instruction

Page 1-14

IM E-mask value (, S-mask value(, P-mask value));

Purpose: Set masks to specify which errors will cause the **ERROR** LED to come on and bit 5 of the status byte to be set, and to specify what conditions will cause a positive response to a serial or parallel poll in an HP-GL environment.

Parameters: integers 0 through 255. If parameters omitted, masks are set to 223,0,0, the default values.

IN The Initialize Instruction

Page 1-13

IN ;

Purpose: Sets the plotter to default conditions plus raises the pen, clears all HP-GL errors, and sets bit 3 of the output status byte to true (1).

The scaling points P1 and P2 are set as follows:

| Paper Size | Scaling Points (Plotter Units) | |
|------------|----------------------------------|----------------------------------|
| | P1 _x ,P1 _y | P2 _x ,P2 _y |
| A | 250,596 | 10 250,7796 |
| A4 | 603,521 | 10 603,7721 |
| B | 522,259 | 15 722,10 259 |
| A3 | 170,602 | 15 370.10 602 |

IP The Input P1 and P2 Instruction

Page 2-7

IP P1_x, P1_y (, P2_x, P2_y) ;

Purpose: Sets scaling points.

Parameters: Integers in plotter units. Omitting parameters sets P1 and P2 to default values as listed above under the IN instruction.

IW The Input Window Instruction

Page 2-12

IW $X_{\text{lower left}}, Y_{\text{lower left}}, X_{\text{upper right}}, Y_{\text{upper right}}$;

Purpose: Sets window inside which plotting can occur.

Parameters: Specify X- and Y-coordinates of lower-left and upper-right corners of the window.

Omitting parameters sets window to maximum plotting area, determined by the setting of the paper switches.

LB The Label Instruction

Page 5-7

LB $c \dots c$ t

Purpose: Draws the character string using the currently selected character set.

Parameters: $c \dots c$ — ASCII characters which may include control characters.

Terminator: t — label terminator defined by DT. Default is ETX, decimal 3.

LT The Line Type Instruction

Page 4-6

LT pattern number (, pattern length) ;

Purpose: Sets the line type used in drawing lines.

Parameters: pattern number — integer between 0 and +6. Omitting parameter causes solid line.

0 specifies dots only at the points that are plotted.

1

2 

3 

4 

5 

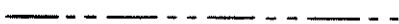
6 

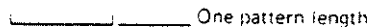
 One pattern length

No parameter (Default Value) 

pattern length — decimal, 0 to 127.9999, a percentage of diagonal distance between P1 and P2. Default 4%.

OA The Output Actual Position and Pen Status Instruction

Page 7-2

OA ;

Purpose: Used to output the pen's physical position at time of instruction.

Response: X,Y,P TERM — integers, in ASCII.
X,Y — in plotter units within current window.
P — 0, pen up or 1, pen down.

OC The Output Commanded Position and Pen Status Instruction

Page 7-3

OC ;

Purpose: Used to output the pen position and status at time of instruction.

Response: X,Y,P TERM — decimal numbers, in ASCII.
X,Y — -32 768.0000 to 32 767.9999.
P — 0, pen up or 1, pen down.

Plotter units unless scaling in effect; then in user units.

OD The Output Digitized Point and Pen Status Instruction

Page 6-3

OD ;

Purpose: Used to output the physical pen position and status for the last digitized point.

Response: X,Y,P TERM — integers, in ASCII.
X,Y — In plotter units, within mechanical limits.
P — 0, pen up or 1, pen down.

OE The Output Error Instruction

Page 7-5

OE ;

Purpose: Used to output the first HP-GL error.

Response: error number TERM — a positive ASCII integer, 0 through 8, excluding 4 and 7.

OP The Output P1 and P2 Instruction

Page 2-8

OP ;

Purpose: Used to output the plotter unit coordinates of the scaling points P1 and P2.

Response: P1_x, P1_y, P2_x, P2_y TERM — four integers in ASCII.

Range — dependent on combination setting of paper switches.

Plotting Ranges

| Paper Size | Plotting Range | |
|------------|-------------------------|-------------------------|
| | X-axis | Y-axis |
| A | $0 \leq X \leq 10\ 365$ | $0 \leq Y \leq 7962$ |
| B | $0 \leq X \leq 16\ 640$ | $0 \leq Y \leq 10\ 365$ |
| A4 | $0 \leq X \leq 11\ 040$ | $0 \leq Y \leq 7721$ |
| A3 | $0 \leq X \leq 16\ 158$ | $0 \leq Y \leq 11\ 040$ |

OS The Output Status Instruction

Page 7-7

OS ;

Purpose: Used to output the plotter's status.

Response: status TERM — integer in ASCII in the range 0 to 255. Power-on status, 24.

OW The Output Window Instruction

Page 2-13

OW ;

Purpose: Used to output the plotter unit coordinates of the lower-left and upper-right corners of the current window.

Response: X_{lower left}, Y_{lower left}, X_{upper right}, Y_{upper right} TERM — integers in ASCII. Range same as OP.

PA The Plot Absolute Instruction

Page 3-4

PA X_1 coordinate, Y_1 coordinate (X_2 coordinate, Y_2 coordinate,
..., ..., X_n coordinate, Y_n coordinate) ;

or

PA ;

Purpose: Plots to the X,Y coordinates in the order listed using the current pen up/down status. *PA* ; sets absolute plotting.

Parameters: Pairs of integers representing plotter units if scaling not in effect, otherwise user units, integers or decimals.

PD The Pen Down Instruction

Page 3-2

PD ;

or

PD X_1 coordinate, Y_1 coordinate (, ... X_n , Y_n coordinates) ;

Purpose: Programmatically lowers the pen. Parameters may be included as in *PA* or *PR*.

PR The Plot Relative Instruction

Page 3-8

PR X_1 increment, Y_1 increment (, X_2 increment, Y_2 increment,
..., ..., X_n increment, Y_n increment) ;

or

PR ;

Purpose: Plots, in order, to the points indicated by the X,Y increments, relative to the previous pen position. *PR* ; sets relative plotting for *PU* or *PD* with parameters.

Parameters: Pairs of integers representing plotter units if scaling is not in effect, otherwise user units, integers, or decimals.

PS The Paper Size Instruction

Page 1-16

PS paper size;

Purpose: Can be used to toggle between A and B, or A3 and A4 paper sizes.

Parameters: 0-3 or 4-127; 0-3 selects either B or A3 size paper; 4-127 selects A or A4 size paper.

PT The Pen Thickness Instruction

Page 3-22

PT (pen thickness);

or

PT ;

Purpose: Determines the spacing between the lines drawn in a solid fill.

Parameters: Decimal between 0.1 mm-5.0 mm. If parameter is omitted, defaults to .3 mm size.

PU The Pen Up Instruction

Page 3-2

PU ;

or

PU X_1 coordinate, Y_1 coordinate (. . . . X_n , Y_n coordinates);

Purpose: Programmatically raises the pen. Parameters may be included as in PA or PR.

RA The Shade Rectangle Absolute Instruction

Page 3-23

RA X-coordinate, Y-coordinate ;

Purpose: Defines and shades a rectangle using absolute coordinates.

Parameters: X- and Y-coordinates

Maximum parameters — decimal, -32 768.0000 through 32 767.9999. In plotter units unless scaling in effect; then in user units. When scaling is off, parameters truncated to integers.

RO The Rotate Coordinate System Instruction

Page 2-14

RO (angle in degrees);

or

RO ;

Purpose: Rotates the coordinate system 90 degrees.

Parameters: 0 or 90; 0 or omitting parameters turns off rotation; 90 rotates coordinate system 90 degrees.

RR The Shade Rectangle Relative Instruction

Page 3-26

RR X-increment, Y-increment ;

Purpose: Defines and shades a rectangle using relative coordinates.

Parameters: X-increment, Y-increment ;

Maximum parameters — decimal, -32 768.0000 through 32 767.9999. In plotter units unless scaling in effect; then in user units. When scaling is off, parameters truncated to integers.

SA The Select Alternate Character Set Instruction

Page 5-4

SA ;

Purpose: Selects the alternate character set designated by the CA instruction as the character set to be used for subsequent labeling.

SC The Scale Instruction

Page 2-9

SC X_{min}, X_{max}, Y_{min}, Y_{max} ;

Purpose: Scales the plotting area into user units.

Parameters: Integers.

SI The Absolute Character Size Instruction

Page 5-16

SI width, height ;

Purpose: Sets character width and height in centimetres for labels.

Parameters: width, height — decimals representing centimetres, -128.0000 to +127.9999 .

An SI instruction with no parameters will default to the following parameters based on the paper size:

| Paper Size | Width | Height |
|------------|---------|---------|
| A/A4 | .187 cm | .269 cm |
| B/A3 | .285 cm | .375 cm |

SL The Character Slant Instruction

Page 5-18

SL $\tan \theta$;

Purpose: Establishes the slant for labeled characters.

Parameters: decimal, -128.0000 to +127.9999, interpreted as the tangent of the angle from vertical.

Omitting parameters establishes no slant, the same as the default or SL0.

SM The Symbol Mode Instruction

Page 4-4

SM character ;

Purpose: Causes specified symbol to be drawn at each plotted point.

Parameter: Any printing character ASCII 33 through 126 excluding semicolon (ASCII 59). SM space, SM control character, or SM; cancels symbol mode.

SP The Pen Select Instruction

Page 3-3

SP pen number ;

Purpose: Selects or stores a pen.

Parameter: integers. Omitting parameters or a parameter of 0 stores the pen.

SR The Relative Character Size Instruction

Page 5-17

SR width, height ;

Purpose: Sets the character width and height relative to P1 and P2 for labels.

Parameters: decimals representing a percentage of vertical or horizontal distance between P1 and P2.

Width — percentage of $(P2_x - P1_x)$.

Height — percentage of $(P2_y - P1_y)$.

Omitting parameters results in value 0.75 for width and 1.5 for height.

SS The Select Standard Character Set Instruction

Page 5-4

SS ;

Purpose: Selects the standard character set designated by the CS instruction as the character set used for subsequent labeling.

TL The Tick Length Instruction

Page 4-2

TL tp (, tn);

Purpose: Establishes the length of ticks drawn with the instructions XT and YT.

Parameters: decimals.

tp — percentage of $(P2_y - P1_y)$ for XT or $(P2_x - P1_x)$ for YT. Denotes portion above the X-axis or to the right of the Y-axis when difference is positive.

tn — same as tp except denotes portion below the X-axis and to the left of the Y-axis.

Omitting parameters causes tick lengths tp and tn 0.5% of $(P2_y - P1_y)$ or $(P2_x - P1_x)$, the same as the default values.

UC The User Defined Character Instruction

Page 5-19

UC (pen control,) X-increment, Y-increment (,...) (, pen control) (,...) ;

Purpose: Draws characters or symbols defined by user.

Parameters: pen control — $\geq +99$ pen down or ≤ -99 pen up.

X-increment, Y-increment in grid units, range, ± 98 grid units.

Omitting parameters causes a carriage return.

VS The Velocity Select Instruction

Page 3-3

VS pen velocity ;

Purpose: Sets the pen velocity.

Parameters: decimal, 0 to 127.9999.

pen velocity — 1 through 38.1 interpreted as cm/s. Defaults to velocity of 38.1 cm/s, acceleration of 2 g. Any velocity parameter slows acceleration to 0.5 g.

WG The Shade Wedge Instruction

Page 3-31

WG radius, start angle, sweep angle(,chord angle) ;

Purpose: Defines and fills a wedge.

Parameters:

| Parameter | Type | Range | Default |
|-------------|---------------------|-------------------------------|---------|
| radius | integer/ decimal | -32 768.0000- +32 767.9999 | none |
| start angle | integer | MOD 360 | none |
| sweep angle | integer | -32 768- +32 767 | none |
| chord angle | integer | 1-120 | 5° |

radius — in plotter units unless scaling in effect; then in X-axis user units. The sign of the radius defines the zero-degree reference point for the start angle and sweep angle.

start angle — a positive start angle positions the radius CCW from the zero-degree reference point; a negative start angle positions the radius CW from the zero-degree reference point.

sweep angle — a positive sweep angle draws the arc segment CCW; a negative sweep angle draws the arc segment CW.

XT The X-Tick Instruction

Page 4-2

XT ;

Purpose: Draws a vertical tick mark of the length specified by the TL instruction at the current pen position.

YT The Y-Tick Instruction

Page 4-2

YT ;

Purpose: Draws a horizontal tick mark of the length specified by the TL instruction at the current pen position.

RS-232-C Instruction Syntax

This section lists the formal syntax for each RS-232-C device control instruction in alphabetical order of the escape sequence. Refer to the indicated page for details.

Plotter On

Page 10-26

ESC . (or **ESC** . Y

Purpose: Places the plotter in a programmed-on state.

Plotter Off

Page 10-26

ESC .) or **ESC** . Z

Purpose: Places the plotter in a programmed-off state.

Set Plotter Configuration

Page 10-27

ESC . @ [(<DEC>); (<DEC>)]:

Purpose: Enables or disables hardwire handshake mode, monitor mode, and data transmission mode.

Parameters: <DEC> — Sets maximum buffer size.

<DEC> — Data Terminal Ready (CD) line control. A decimal number in the range of 0-31.

Output Buffer Space

Page 10-28

ESC . B

Purpose: Outputs the number of byte spaces currently available for data in the buffer.

Response: <DEC> TERM — 0 to 1024.

Output Extended Error

Page 10-29

ESC . E

Purpose: Outputs a decimal code to identify the type of RS-232-C related error that occurred.

Response: <DEC> TERM — 0, no error, or 10 - 16.

Set Handshake Mode 1

Page 10-32

ESC . H [(**<DEC>**);(**<ASC>**);(**<ASC>**(;...**<ASC>**))]:

Purpose: Establishes parameters for handshake mode 1, used when response to handshake enable character requires ESC . M parameters.

Parameters: **<DEC>** — Block size or Xoff threshold level.

<ASC> — Handshake enable character or not used.

<ASC> ... **<ASC>** — Handshake response string of 1 to 10 characters or Xon trigger characters.

Set Handshake Mode 2

Page 10-33

ESC . I [(**<DEC>**);(**<ASC>**);(**<ASC>**(;...**<ASC>**))]:

Purpose: Establishes parameters for handshake mode 2, used when response to handshake enable character does not require ESC . M parameters.

Parameters: **<DEC>** — Block size or Xoff threshold level.

<ASC> — Handshake enable character or omitted.

<ASC> ... **<ASC>** — Handshake response string of 1 to 10 characters or Xon trigger characters.

Abort Device Control

Page 10-35

ESC . J

Purpose: Aborts any partially decoded or executed device control instructions including outputs.

Abort Graphic Instruction

Page 10-36

ESC . K

Purpose: Aborts any partially decoded HP-GL instruction and discards instructions in buffer.

Output Buffer Size

Page 10-36

ESC . L

Purpose: Outputs the buffer size.

Response: 1024. Not output until the buffer is empty.

Set Output Mode

Page 10-37

ESC . M [(**<DEC>**);(**<ASC>**);(**<ASC>**);(**<ASC>**);(**<ASC>**)];
(**<ASC>**)]:

Purpose: Sets parameters for output.

Parameters: **<DEC>** — Turnaround delay, 0-54 612.

<ASC> — Output trigger character, ASCII 0-127.

<ASC> — Echo terminator character, ASCII 0-127.

<ASC> ... **<ASC>** — 1 or 2 output terminators, ASCII 0-127, 0 terminates string.

<ASC> — Output initiator character, ASCII 0-127.

Set Extended Output and Handshake Mode

Page 10-38

ESC . N [(**<DEC>**);(**<ASC>**); ... **<ASC>**)]:

Purpose: Establishes extended parameters for any output instruction.

Parameters: **<DEC>** — Delay between output characters, 0-54 612.

<ASC> ... **<ASC>** — Immediate response string of 1 to 10 characters. ASCII 0-127, 0 terminates string; or Xoff trigger characters.

Output Extended Status

Page 10-42

ESC . O

Purpose: Outputs the decimal equivalent value of a 16-bit immediate status word.

Response: **<DEC>** TERM — a value 40 or less.

Reset Handshake

Page 10-44

ESC . R

Purpose: Resets the handshake to its default value. It is the same as sending the commands **ESC . @**, **ESC . H**, **ESC . I**, **ESC . M**, and **ESC . N** without parameters.

Appendix **C**

Reference Material

Binary Coding and Conversions

Binary is a base 2 number system using only 1's and 0's. By giving the 1's and 0's positional value, any decimal number can be represented. For example, this diagram shows how decimal 41 = binary 101001:

| | | | | | | |
|---|---|---|---|---|----------------|-----|
| Decimal | | | | | | |
| $4 \times 10^1 + 1 \times 10^0$ | | | | | | |
| $4 \times 10 + 1 \times 1$ | | | | | | |
| <hr style="width: 100%;"/> | | | | | | |
| 4 | | | | | | 110 |
| Binary | | | | | | |
| $1 \times 2^5 + 0 \times 2^4 + 1 \times 2^3 + 0 \times 2^2 + 0 \times 2^1 + 1 \times 2^0$ | | | | | | |
| $1 \times 32 + 0 \times 16 + 1 \times 8 + 0 \times 4 + 0 \times 2 + 1 \times 1$ | | | | | | |
| <hr style="width: 100%;"/> | | | | | | |
| 1 | 0 | 1 | 0 | 0 | 1 | |
| | | | | | 1 ₂ | |

Binary-Decimal Conversions

To convert from binary to decimal, the positional values of the 1's are added up. From the above example, this would be:

$$2^5 + 2^3 + 2^0 = 32 + 8 + 1 = 41$$

To convert from decimal to binary, the decimal number is divided by 2. The remainder is the binary equivalent. For example:

| | | | | | | |
|---|----|---|---|-----------------|--|--|
| | | | | Remainder | | |
| | | | | (read up) | | |
| 2 | 41 | - | 1 | | | |
| 2 | 20 | - | 0 | | | |
| 2 | 10 | - | 0 | | | |
| 2 | 5 | - | 1 | | | |
| 2 | 2 | - | 0 | | | |
| 2 | 1 | - | 1 | | | |
| | | | | = Binary 101001 | | |

Scaling Without Using the SC Instruction

The 7475 plotter movements are in terms of plotter units where a plotter unit = 0.025 mm. While the plotter can be scaled into user units using the SC instruction, it may be convenient for you to write programs where numbers to be plotted are in some units other than plotter units. These "user units" can be converted into plotter units by the computer using the following equations:

$$X_{\text{scaled}} = \left[\frac{P2_x - P1_x}{U2_x - U1_x} \right] A_x + P1_x - U1_x \left[\frac{P2_x - P1_x}{U2_x - U1_x} \right]$$

$$Y_{\text{scaled}} = \left[\frac{P2_y - P1_y}{U2_y - U1_y} \right] A_y + P1_y - U1_y \left[\frac{P2_y - P1_y}{U2_y - U1_y} \right]$$

where: A_x is the X-coordinate of the desired point in user units,
 A_y is the Y-coordinate of the desired point in user units,
 $P1_x$ is the X-coordinate of P1 in plotter units,
 $P1_y$ is the Y-coordinate of P1 in plotter units,
 $P2_x$ is the X-coordinate of P2 in plotter units,
 $P2_y$ is the Y-coordinate of P2 in plotter units,
 $U1_x$ is the X-coordinate of P1 in user units,
 $U1_y$ is the Y-coordinate of P1 in user units,
 $U2_x$ is the X-coordinate of P2 in user units, and
 $U2_y$ is the Y-coordinate of P2 in user units.

To demonstrate the use of the scaling equations, let's go through an example.

Example 1:

Problem

Scale the platen area ($P1 = 250,596$ and $P2 = 10\,250,7796$) into user units where $P1 = 0,0$ and $P2 = 25\,000,18\,000$. At the center point ($X = 12\,500$, $Y = 9000$), draw a circle with radius 2500 as shown on the following page.

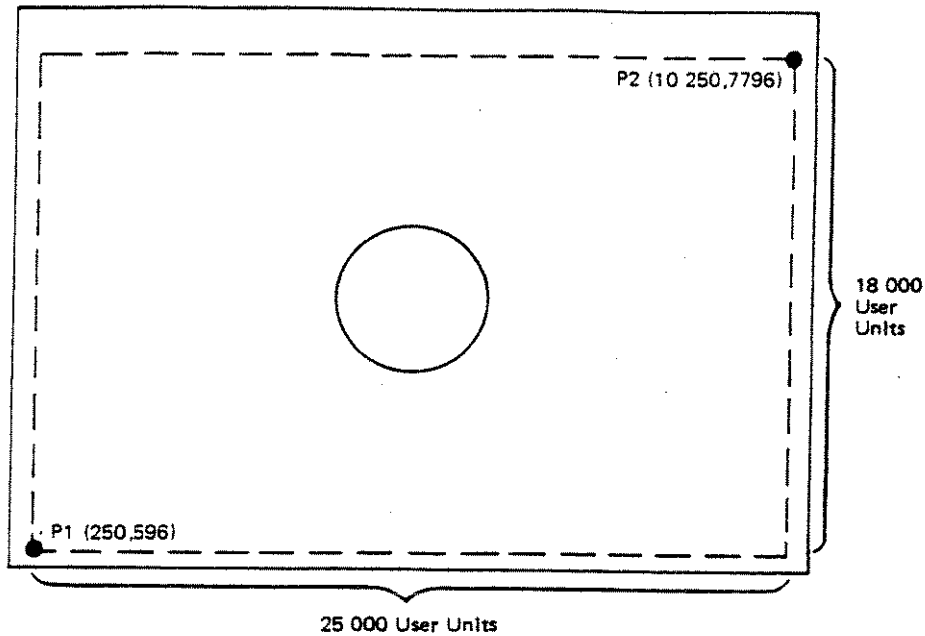

Solution

- A. Recall that the equations of a circle are:

$$\begin{aligned}
 X &= R \cos t \\
 Y &= R \sin t \\
 \text{where } 0 &\leq t \leq 2\pi
 \end{aligned}$$

- B. Since we are to plot relative to a point that is not at the origin, an offset X_0 , Y_0 must be added to the circle equations. The offset in user units is:

$$\begin{aligned}
 X_0 &= 12\,500 \\
 Y_0 &= 9000
 \end{aligned}$$

- C. The desired circle equations are then:

$$\begin{aligned}
 A_x &= 2500 \cos t + 12\,500 \\
 A_y &= 2500 \sin t + 9000
 \end{aligned}$$

- D. Determine the user scale:

$$\begin{aligned}
 X &= 0 \text{ to } 25\,000 \\
 Y &= 0 \text{ to } 18\,000
 \end{aligned}$$

therefore

$$\begin{aligned}
 U_{1x} &= 0 \\
 U_{1y} &= 0 \\
 U_{2x} &= 25\,000 \\
 U_{2y} &= 18\,000
 \end{aligned}$$

E. Determine the values for P1 and P2 which were set using the IN instruction:

$$P1 = 250, 596$$

$$P2 = 10\,250, 7796$$

therefore

$$P1_x = 250$$

$$P1_y = 596$$

$$P2_x = 10\,250$$

$$P2_y = 7796$$

F. Solving for X and Y:

$$X = \frac{P2_x - P1_x}{U2_x - U1_x} A_x + P1_x - U1_x \frac{P2_x - P1_x}{U2_x - U1_x}$$

$$= \frac{10\,250 - 250}{25\,000 - 0} (2500 \cos t + 12\,500) + 250 - 0 \frac{10\,250 - 250}{25\,000 - 0}$$

$$= 0.4 (2500 \cos t + 12\,500) + 250 - 0$$

$$= 1000 \cos t + 5250$$

$$Y = \frac{P2_y - P1_y}{U2_y - U1_y} A_y + P1_y - U1_y \frac{P2_y - P1_y}{U2_y - U1_y}$$

$$+ \frac{7796 - 596}{18\,000 - 0} (2500 \sin t + 9000) + 596 - 0 \frac{7796 - 596}{18\,000 - 0}$$

$$= 0.4 (2500 \sin t + 9000) + 596 - 0$$

$$= 1000 \sin t + 4196$$

G. Sending the following program will plot the required circle using the default P1 and P2.

```
10 PRINT "IP250,596,10250,7796;SP1;"
20 FOR T=0 TO 2*PI STEP PI/20
30 X=1000*COS(T)+5250
40 Y=1000*SIN(T)+4196
50 PRINT "PA";X;Y;"PD"
60 NEXT T
70 PRINT "SPO;"
```

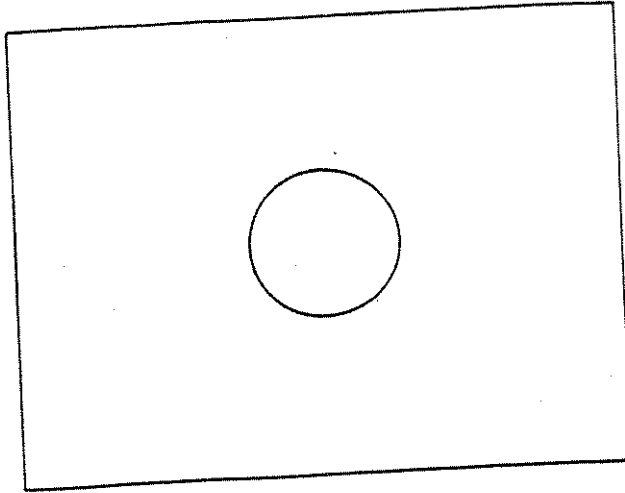

Plotter Default Conditions

| | |
|------------------------------|---|
| Plotting mode | Absolute (PA) |
| Relative character direction | Horizontal (DR 1, 0) |
| Line type | Solid line |
| Line pattern length | 4% of the distance from P1 to P2 |
| Fill type | Set to type 1 bidirectional solid fill |
| Fill spacing | 1% of the diagonal distance between P1 and P2 |
| Fill angle | Set to 0° |
| Input window | Mechanical limits of plotter |
| Relative character size | (SR.75, 1.5) width = 0.75% of (P2 _x - P1 _x) height = 1.5% of (P2 _y - P1 _y) |
| Scale | Off |
| Symbol mode | Off |
| Tick length | tp and tn = 0.5% of (P2 _x - P1 _x) for Y-tick and 0.5% of (P2 _y - P1 _y) for X-tick |
| Character set selected | Standard |
| Standard character set | Set 0 |
| Alternate character set | Set 0 |
| Label terminator | ETX (ASCII decimal equivalent 3) |
| Character slant | 0° |
| Mask value | 223, 0, 0 |

| | |
|----------------|-------------------------------------|
| Digitize clear | On |
| Pen velocity | 38.1 cm/s (15 in./s) |
| Pen thickness | Set to 0.3 mm |
| Chord angle | Set to 5 degrees for AA, AR, and CI |

P1 and P2 are changed only with the initialize instruction (IN). They are not affected by device clear and the default instruction (DF).

HP-GL Error Messages

- error 0 No error.
- error 1 Instruction not recognized. The plotter has received an illegal character sequence.
- error 2 Wrong number of parameters. Too many or too few parameters have been sent with an instruction.
- error 3 Out-of-range parameters.
- error 4 Not used.
- error 5 Unknown character set. A character set out of the range 0-4, 6-9, 30-39 has been designated as either the standard or alternate character set.
- error 6 Position overflow. An attempt to draw a character (LB or UC) or perform a CP that is located outside the plotter's numeric limit of -32 768 to +32 767.
- error 7 Not used.
- error 8 Vector received while pinch wheels raised.

RS-232-C Error Messages

- 0 No I/O error has occurred.
- 10 Output instruction received while another output instruction is executing. The original instruction will continue normally; the one in error will be ignored.
- 11 Invalid byte received after first two characters, **ESC** . , in a device control instruction.
- 12 Invalid byte received while parsing a device control instruction. The parameter containing the invalid byte and all following parameters are defaulted.
- 13 Parameter out of range.

- 14 Too many parameters received. Additional parameters beyond the proper number are ignored; parsing of the instruction ends when a colon (normal exit) or the first byte of another instruction is received (abnormal exit).
- 15 A framing error, parity error, or overrun error has been detected.
- 16 The input buffer has overflowed. As a result, one or more bytes of data have been lost, and therefore, an HP-GL error will probably occur.

The No Operation Instructions, NOP

In order to maintain software compatibility with the 9872 plotter, the 7475 recognizes six 9872-related instructions as no operation NOP instructions. These six NOP instructions are:

| | |
|-------------------------|-------------------------------|
| Automatic Pen Pickup AP | Advance Full Page AF, PG, PG1 |
| Adaptive Velocity VA | Advance Half Page AH |
| Normal Velocity VN | Enable Cutter EC |

If these instructions are included in a program, they are recognized by the 7475 and implemented as a NOP (i.e., they are ignored).

ASCII Character Codes

Numbers are often used as a code to represent not only values, but also alphanumeric characters such as "A" or "," or "x" or "2". One of the most common computer codes used is ASCII¹. ASCII is an eight-bit code, containing seven data bits and one parity bit. The plotter uses ASCII for most I/O operations. No parity bit is used. For example:

| <u>Character</u> | <u>ASCII Binary Code</u> | <u>ASCII Decimal Code</u> |
|------------------|------------------------------|-------------------------------|
| A | 01000001 | 65 |
| B | 01000010 | 66 |
| ? | 00111111 | 63 |

¹American Standard Code for Information Interchange.

A complete list of ASCII characters and their decimal representation and the characters drawn by the plotter in each of the 19 character sets are shown on the following pages. The 19 character sets are:

| <u>Set No.</u> | <u>Description</u> | <u>ISO Registration Number</u> |
|----------------|---|--------------------------------|
| Set 0 | ANSI ASCII | 006 |
| Set 1 | 9825 Character Set | — |
| Set 2 | French/German | — |
| Set 3 | Scandinavian | — |
| Set 4 | Spanish/Latin American | — |
| Set 6 | JIS ASCII | 014 |
| Set 7 | Roman Extensions | — |
| Set 8 | Katakana | 013 |
| Set 9 | ISO IRV (International Reference Version) | 002 |
| Set 30 | ISO Swedish | 010 |
| Set 31 | ISO Swedish For Names | 011 |
| Set 32 | ISO Norway, Version 1 | 060 |
| Set 33 | ISO German | 021 |
| Set 34 | ISO French | 025 |
| Set 35 | ISO United Kingdom | 004 |
| Set 36 | ISO Italian | 015 |
| Set 37 | ISO Spanish | 017 |
| Set 38 | ISO Portuguese | 016 |
| Set 39 | ISO Norway, Version 2 | 061 |

7475 ASCII Code Definitions

| Decimal Value | ASCII Character | All Sets |
|---------------|-----------------|--------------------------------|
| 0 | NULL | No Operation (NOP) |
| 1 | SOH | NOP |
| 2 | STX | NOP |
| 3 | ETX | End Label Instruction |
| 4 | ETO | NOP |
| 5 | ENQ | NOP |
| 6 | ACK | NOP |
| 7 | BEL | NOP |
| 8 | BS | Backspace |
| * 9 | HT | Horizontal Tab (1/2 backspace) |
| 10 | LF | Line Feed |
| 11 | VT | Inverse Line Feed |
| 12 | FF | NOP |
| 13 | CR | Carriage Return |
| 14 | SO | Select Alternate Character Set |
| 15 | SI | Select Standard Character Set |
| 16 | DLE | NOP |
| 17 | DC1 | NOP |
| 18 | DC2 | NOP |
| 19 | DC3 | NOP |
| 20 | DC4 | NOP |
| 21 | NAK | NOP |
| 22 | SYN | NOP |
| 23 | ETB | NOP |
| 24 | CAN | NOP |
| 25 | EM | NOP |
| 26 | SUB | NOP |
| 27 | ESC | NOP |
| 28 | FS | NOP |
| 29 | GS | NOP |
| 30 | RS | NOP |
| 31 | US | NOP |
| 32 | SP | Space |

*Using control character horizontal tab (decimal 9) inside a label string moves the pen one-half character space back (equivalent to a CP -.5,0). Use this tab with character set 8, Katakana, where spacing between symbols can alter the meaning of the symbol and hence the word or phrase.

NOTE: Shaded characters have the automatic backspace feature. ■

7475 ASCII Code Definitions (Continued)

| Decimal Value | SET | | | | | | | | | | | | | | | | | | |
|---------------|-----|----|----|----|----|----|---|---|---|----|----|----|----|----|----|----|----|----|----|
| | 0 | 1 | 2 | 3 | 4 | 6 | 7 | 8 | 9 | 30 | 31 | 32 | 33 | 34 | 35 | 36 | 37 | 38 | 39 |
| 33 | ! | ! | ! | ! | ! | ! | À | . | ! | ! | ! | ! | ! | ! | ! | ! | ! | ! | ! |
| 34 | " | " | " | " | " | " | Á | ¡ | " | " | " | " | " | " | " | " | " | " | " |
| 35 | # | # | £ | £ | £ | # | Ê | ¡ | # | # | # | # | # | £ | £ | £ | £ | # | § |
| 36 | \$ | \$ | \$ | \$ | \$ | \$ | Ë | . | ¤ | ¤ | ¤ | ¤ | ¤ | ¤ | ¤ | ¤ | ¤ | ¤ | ¤ |
| 37 | % | % | % | % | % | % | Ë | . | % | % | % | % | % | % | % | % | % | % | % |
| 38 | & | & | & | & | & | & | Ì | ¿ | & | & | & | & | & | & | & | & | & | & | & |
| 39 | ' | ' | ' | ' | ' | ' | Í | > | ' | ' | ' | ' | ' | ' | ' | ' | ' | ' | ' |
| 40 | (| (| (| (| (| (| Î | (| (| (| (| (| (| (| (| (| (| (| (|
| 41 |) |) |) |) |) |) | Ï |) |) |) |) |) |) |) |) |) |) |) |) |
| 42 | * | * | * | * | * | * | Ĳ | * | * | * | * | * | * | * | * | * | * | * | * |
| 43 | + | + | + | + | + | + | Ŧ | + | + | + | + | + | + | + | + | + | + | + | + |
| 44 | , | , | , | , | , | , | Û | , | , | , | , | , | , | , | , | , | , | , | , |
| 45 | - | - | - | - | - | - | Ü | - | - | - | - | - | - | - | - | - | - | - | - |
| 46 | . | . | . | . | . | . | Ý | . | . | . | . | . | . | . | . | . | . | . | . |
| 47 | / | / | / | / | / | / | ÿ | / | / | / | / | / | / | / | / | / | / | / | / |
| 48 | 0 | 0 | 0 | 0 | 0 | 0 | ˆ | 0 | 0 | 0 | 0 | 0 | 0 | 0 | 0 | 0 | 0 | 0 | 0 |
| 49 | 1 | 1 | 1 | 1 | 1 | 1 | ¸ | 1 | 1 | 1 | 1 | 1 | 1 | 1 | 1 | 1 | 1 | 1 | 1 |
| 50 | 2 | 2 | 2 | 2 | 2 | 2 | ¸ | 2 | 2 | 2 | 2 | 2 | 2 | 2 | 2 | 2 | 2 | 2 | 2 |
| 51 | 3 | 3 | 3 | 3 | 3 | 3 | ¸ | 3 | 3 | 3 | 3 | 3 | 3 | 3 | 3 | 3 | 3 | 3 | 3 |
| 52 | 4 | 4 | 4 | 4 | 4 | 4 | ¸ | 4 | 4 | 4 | 4 | 4 | 4 | 4 | 4 | 4 | 4 | 4 | 4 |
| 53 | 5 | 5 | 5 | 5 | 5 | 5 | ¸ | 5 | 5 | 5 | 5 | 5 | 5 | 5 | 5 | 5 | 5 | 5 | 5 |
| 54 | 6 | 6 | 6 | 6 | 6 | 6 | ¸ | 6 | 6 | 6 | 6 | 6 | 6 | 6 | 6 | 6 | 6 | 6 | 6 |
| 55 | 7 | 7 | 7 | 7 | 7 | 7 | ¸ | 7 | 7 | 7 | 7 | 7 | 7 | 7 | 7 | 7 | 7 | 7 | 7 |
| 56 | 8 | 8 | 8 | 8 | 8 | 8 | ¸ | 8 | 8 | 8 | 8 | 8 | 8 | 8 | 8 | 8 | 8 | 8 | 8 |
| 57 | 9 | 9 | 9 | 9 | 9 | 9 | ¸ | 9 | 9 | 9 | 9 | 9 | 9 | 9 | 9 | 9 | 9 | 9 | 9 |
| 58 | : | : | : | : | : | : | ¸ | : | : | : | : | : | : | : | : | : | : | : | : |
| 59 | : | : | : | : | : | : | ¸ | : | : | : | : | : | : | : | : | : | : | : | : |
| 60 | < | < | < | < | < | < | ¸ | < | < | < | < | < | < | < | < | < | < | < | < |
| 61 | = | = | = | = | = | = | ¸ | = | = | = | = | = | = | = | = | = | = | = | = |
| 62 | > | > | > | > | > | > | ¸ | > | > | > | > | > | > | > | > | > | > | > | > |
| 63 | ? | ? | ? | ? | ? | ? | ¸ | ? | ? | ? | ? | ? | ? | ? | ? | ? | ? | ? | ? |
| 64 | @ | @ | @ | @ | @ | @ | ¸ | @ | @ | @ | @ | @ | @ | @ | @ | @ | @ | @ | @ |

7475 ASCII Code Definitions (Continued)

| Decimal Value | SET | | | | | | | | | | | | | | | | | | |
|---------------|-----|---|---|---|---|---|---|---|---|----|----|----|----|----|----|----|----|----|----|
| | 0 | 1 | 2 | 3 | 4 | 6 | 7 | 8 | 9 | 30 | 31 | 32 | 33 | 34 | 35 | 36 | 37 | 38 | 39 |
| 65 | A | A | A | A | A | A | ê | ƒ | A | A | A | A | A | A | A | A | A | A | A |
| 66 | B | B | B | B | B | B | ô | ƒ | B | B | B | B | B | B | B | B | B | B | B |
| 67 | C | C | C | C | C | C | ô | ƒ | C | C | C | C | C | C | C | C | C | C | C |
| 68 | D | D | D | D | D | D | á | † | D | D | D | D | D | D | D | D | D | D | D |
| 69 | E | E | E | E | E | E | é | ƒ | E | E | E | E | E | E | E | E | E | E | E |
| 70 | F | F | F | F | F | F | ó | ƒ | F | F | F | F | F | F | F | F | F | F | F |
| 71 | G | G | G | G | G | G | ú | ƒ | G | G | G | G | G | G | G | G | G | G | G |
| 72 | H | H | H | H | H | H | à | ƒ | H | H | H | H | H | H | H | H | H | H | H |
| 73 | I | I | I | I | I | I | è | ƒ | I | I | I | I | I | I | I | I | I | I | I |
| 74 | J | J | J | J | J | J | ò | ƒ | J | J | J | J | J | J | J | J | J | J | J |
| 75 | K | K | K | K | K | K | ù | ƒ | K | K | K | K | K | K | K | K | K | K | K |
| 76 | L | L | L | L | L | L | ä | ƒ | L | L | L | L | L | L | L | L | L | L | L |
| 77 | M | M | M | M | M | M | ë | ƒ | M | M | M | M | M | M | M | M | M | M | M |
| 78 | N | N | N | N | N | N | ö | ƒ | N | N | N | N | N | N | N | N | N | N | N |
| 79 | O | O | O | O | O | O | ö | ƒ | O | O | O | O | O | O | O | O | O | O | O |
| 80 | P | P | P | P | P | P | á | ƒ | P | P | P | P | P | P | P | P | P | P | P |
| 81 | Q | Q | Q | Q | Q | Q | í | ƒ | Q | Q | Q | Q | Q | Q | Q | Q | Q | Q | Q |
| 82 | R | R | R | R | R | R | ø | ƒ | R | R | R | R | R | R | R | R | R | R | R |
| 83 | S | S | S | S | S | S | æ | ƒ | S | S | S | S | S | S | S | S | S | S | S |
| 84 | T | T | T | T | T | T | á | ƒ | T | T | T | T | T | T | T | T | T | T | T |
| 85 | U | U | U | U | U | U | í | ƒ | U | U | U | U | U | U | U | U | U | U | U |
| 86 | V | V | V | V | V | V | ø | ƒ | V | V | V | V | V | V | V | V | V | V | V |
| 87 | W | W | W | W | W | W | z | ƒ | W | W | W | W | W | W | W | W | W | W | W |
| 88 | X | X | X | X | X | X | á | ƒ | X | X | X | X | X | X | X | X | X | X | X |
| 89 | Y | Y | Y | Y | Y | Y | í | ƒ | Y | Y | Y | Y | Y | Y | Y | Y | Y | Y | Y |
| 90 | Z | Z | Z | Z | Z | Z | ö | ƒ | Z | Z | Z | Z | Z | Z | Z | Z | Z | Z | Z |
| 91 | [| [| [| [| [| [| ü | ƒ | [| á | á | æ | á | · | [| · | í | á | æ |
| 92 | \ | ƒ | c | æ | í | ƒ | é | ƒ | \ | ö | ö | ø | ö | c | \ | c | Ñ | C | ø |
| 93 |] |] |] |] |] |] | í | ƒ |] | á | á | á | ü | š | í | é | z | ö | á |
| 94 | ^ | ^ | ^ | ^ | ^ | ^ | ø | ƒ | ^ | ^ | ^ | ^ | ^ | ^ | ^ | ^ | ^ | ^ | ^ |
| 95 | _ | _ | _ | _ | _ | _ | ö | ƒ | _ | _ | _ | _ | _ | _ | _ | _ | _ | _ | _ |
| 96 | ~ | ~ | ~ | ~ | ~ | ~ | á | ƒ | ~ | ~ | ~ | ~ | ~ | ~ | ~ | ~ | ~ | ~ | ~ |

7475 ASCII Code Definitions (Continued)

| Decimal Value | SET | | | | | | | | | | | | | | | | | | | |
|---------------|-----|---|---|---|---|---|---|---|---|----|----|----|----|----|----|----|----|----|----|---|
| | 0 | 1 | 2 | 3 | 4 | 6 | 7 | 8 | 9 | 30 | 31 | 32 | 33 | 34 | 35 | 36 | 37 | 38 | 39 | |
| 97 | a | a | a | a | a | a | Ã | | | a | a | a | a | a | a | a | a | a | a | |
| 98 | o | b | b | b | b | b | ã | | | b | b | b | b | b | b | b | b | b | b | |
| 99 | c | c | c | c | c | c | ð | | | c | c | c | c | c | c | c | c | c | c | |
| 100 | d | d | d | d | d | d | đ | | | d | d | d | d | d | d | d | d | d | d | |
| 101 | e | e | e | e | e | e | é | | | e | e | e | e | e | e | e | e | e | e | |
| 102 | f | f | f | f | f | f | ì | | | f | f | f | f | f | f | f | f | f | f | |
| 103 | g | g | g | g | g | g | ó | | | g | g | g | g | g | g | g | g | g | g | |
| 104 | h | h | h | h | h | h | ò | | | h | h | h | h | h | h | h | h | h | h | |
| 105 | i | i | i | i | i | i | õ | | | i | i | i | i | i | i | i | i | i | i | |
| 106 | j | j | j | j | j | j | ö | | | j | j | j | j | j | j | j | j | j | j | |
| 107 | k | k | k | k | k | k | š | | | k | k | k | k | k | k | k | k | k | k | |
| 108 | l | l | l | l | l | l | ë | | | l | l | l | l | l | l | l | l | l | l | |
| 109 | m | m | m | m | m | m | ú | | | m | m | m | m | m | m | m | m | m | m | |
| 110 | n | n | n | n | n | n | ÿ | | | n | n | n | n | n | n | n | n | n | n | |
| 111 | o | o | o | o | o | o | ÿ | | | o | o | o | o | o | o | o | o | o | o | |
| 112 | p | p | p | p | p | p | þ | | | p | p | p | p | p | p | p | p | p | p | |
| 113 | q | q | q | q | q | q | q | | | q | q | q | q | q | q | q | q | q | q | |
| 114 | r | r | r | r | r | r | r | | | r | r | r | r | r | r | r | r | r | r | |
| 115 | s | s | s | s | s | s | s | | | s | s | s | s | s | s | s | s | s | s | |
| 116 | t | t | t | t | t | t | t | | | t | t | t | t | t | t | t | t | t | t | |
| 117 | u | u | u | u | u | u | u | | | u | u | u | u | u | u | u | u | u | u | |
| 118 | v | v | v | v | v | v | - | | | v | v | v | v | v | v | v | v | v | v | |
| 119 | w | w | w | w | w | w | ½ | | | w | w | w | w | w | w | w | w | w | w | |
| 120 | x | x | x | x | x | x | ½ | | | x | x | x | x | x | x | x | x | x | x | |
| 121 | y | y | y | y | y | y | ¾ | | | y | y | y | y | y | y | y | y | y | y | |
| 122 | z | z | z | z | z | z | ¾ | | | z | z | z | z | z | z | z | z | z | z | |
| 123 | { | π | - | - | ~ | { | < | | | { | ä | ä | æ | ä | é | { | à | · | ä | æ |
| 124 | | ƒ | - | - | ~ | | □ | | | | ö | ö | ø | ö | ù | | ò | ñ | ç | ø |
| 125 | } | - | - | - | ~ | } | > | | | } | á | á | á | ü | è | } | è | ç | ö | á |
| 126 | - | - | - | - | - | - | ± | | | - | - | ó | - | ß | - | - | í | - | · | - |

Subject Index

a

AA Instruction 3-16 thru 3-18, B-1
AR Instruction 3-18 thru 3-20, B-2
<ASC> 10-25
Abort Device Control, ESC . J 10-35, 10-36, B-18
Abort Graphic, ESC . K 10-36, B-18
Absolute Direction Instruction, DI 5-10, 5-25, 5-26, B-3
Absolute Plotting 3-1, 3-4
Absolute Size Instruction, SI 5-14, 5-16, 5-25, B-13
Acceleration 1-5, 3-3
Acknowledgment String 10-17, 10-22, 10-32 thru 10-35, 10-41
Addressing the Plotter, HP-IB 9-2, 9-3, 9-6
Arc Absolute Instruction, AA 3-16 thru 3-18, B-1
Arc Relative Instruction, AR 3-18 thru 3-20, B-2
ASCII Character Codes C-7 thru C-12

b

Bar Graphs 1-15, 8-1, 8-9 thru 8-12
Baud Rate 10-13
Binary Coding and Conversions C-1
Binary-Decimal Conversions C-1
Block Data Transfer Mode 10-23, 10-24, 10-28, 10-30
Block Size 10-17, 10-21, 10-22, 10-32, 10-33, 10-34, 10-41
Break Signal 10-6 10-7, 10-8, 10-26, 10-27
Buffer Space 10-14 10-15, 10-17 thru 10-23, 10-28, 10-36, 10-42
Bus Commands 9-4

c

CA Instruction 5-3, 5-4, 5-7, B-2
CI Instruction 3-11 thru 3-15, B-2
CP Instruction 5-14, 5-15, 5-16, 5-22, 8-3, 8-4, 8-9, B-2
CS Instruction 5-3, 5-4, 5-7, B-3
Carriage-return Point 5-8, 5-10, 5-11, 5-14
CCITT V.24 Interface 1-1, 1-2, 10-1, 10-2, 10-10, 10-11, 10-12
Character Grid 5-20
Character Plot Instruction, CP 5-14, 5-15, B-2
Character Sets 5-2, C-7 thru C-12
Character Size 5-16, 5-23, B-13
Character Slant Instruction, SL 5-18, B-14
Character Space Field 5-1, 5-13, 5-20
Circle Instruction, CI 3-11 thru 3-15, B-2
Clipping 2-1, 2-12, 2-14
Connecting the RS-232-C Interface 10-10

Subject Index (Continued)

Connector Cable, RS-232-C 10-10, 10-11, 10-12
Current Pen Position 3-1, 3-8, 5-8

d

DC Instruction 6-3, B-3
DCL 9-4
<DEC> 10-25
DF Instruction 1-11, 3-4, 3-6, B-3
DI Instruction 5-10, 5-23, 5-25, B-3
DP Instruction 6-2, B-3
DR Instruction 5-11, 5-24, 5-27, B-3
DT Instruction 5-5, B-4
Data Block Size 10-17, 10-21, 10-22, 10-32, 10-33
Data Terminal Ready Line Control 10-17, 10-22, 10-27
Data Transmission Mode 10-23, 10-24, 10-27, 10-28
Decimal Format 1-7
Default Conditions 1-12, C-5
Default Instruction, DF 1-11, 3-4, 3-6, B-3
Define Terminator Instruction, DT 5-5, B-4
Designate Alternate Character Set, CA 5-3, 5-4, 5-7, B-2
Designate Standard Set Instruction, CS 5-3, 5-4, 5-7, B-3
Device Clear 9-4
Device Control Instructions, RS-232-C 10-1, 10-2, 10-3,
10-24 thru 10-44, B-17, B-18, B-19
Digitize Clear Instruction, DC 6-3, B-3
Digitize Point Instruction, DP 6-2, B-3
Digitizing 6-1, 6-2, 6-4
Digitizing Sight 6-2
Documentation for the 7475 1-2

e

EA Instruction 3-25, 8-10, 8-12, B-4
ER Instruction 3-28, B-4
EW Instruction 3-34, 8-15, B-4
ESC . (..... 10-7, 10-10, 10-26, B-17
ESC .) 10-26, B-17
ESC . @ 10-8, 10-23, 10-27, 10-44, B-17
ESC . B 10-19, 10-28, 10-29, B-17
ESC . E 10-14, 10-29, 10-30, B-17
ESC . H 10-21, 10-22, 10-32, 10-33, 10-44, B-18
ESC . I 10-21, 10-22, 10-32, 10-33, 10-41, 10-42, 10-44, B-18
ESC . J 10-35, 10-36, B-18

Subject Index (Continued)

ESC. K 10-36, B-18
ESC. L 10-36, B-18
ESC. M 10-18, 10-21, 10-25, 10-32, 10-37, 10-44, B-19
ESC. N 10-18, 10-21, 10-32, 10-38, 10-41, 10-44, B-19
ESC. O 10-42, B-19
ESC. R 10-44, B-19
ESC. Y 10-7, 10-10, 10-26, B-17
ESC. Z 10-26, B-17
E-mask 1-13, 1-14
Eavesdrop Environment, RS-232-C 10-4
Echo Terminate Character 10-16, 10-18, 10-21,
10-22, 10-33, 10-35, 10-37, 10-40
Edge Rectangle Absolute Instruction, EA 3-25, 8-10, 8-12, B-4
Edge Rectangle Relative Instruction, ER 3-28, B-4
Edge Wedge Instruction, EW 3-34, 8-15, B-4
Endline Environment 10-3
Enquire/Acknowledge Handshake 10-15, 10-21, 10-22,
10-23, 10-32 thru 10-35, 10-43
Enquiry Character 10-16, 10-21, 10-22, 10-32 thru 10-35, 10-41
Error Light 7-6, 10-14, 10-29, 10-30
Error Messages, HP-IB 7-5, C-6
Error Messages, RS-232-C 10-29, 10-30, C-6
ETX, End of Text Character 1-7, 5-5, 5-6, 5-11
Extended Status 10-42, 10-43
External Clock 10-13, 10-14

f

FT Instruction 3-21, 8-10, 8-12, 8-13, 8-15, B-5
Fill Type Instruction, FT 3-21, 8-10, 8-12, 8-13, 8-15, B-5

h

HP-GL Error Status 1-14, 7-5, C-6
HP-GL Instruction Set 1-6, 1-8 thru 1-10, B-1 thru B-16
HP-GL Syntax 1-6 thru 1-10, B-1 thru B-16
HP-IB 7-6, A-1 thru A-8
HP-IB Implementation 9-2, A-2, A-3
HP-IB Interfacing 9-1 thru 9-6, A-1 thru A-8
Half Duplex 10-10
Handshake Mode 1 10-32, 10-33, 10-34
Handshake Mode 2 10-32, 10-33, 10-34
Handshaking 10-15 thru 10-23

Subject Index (Continued)

Hard-clip Area 2-12
Hardwire Handshake 10-15, 10-22, 10-27
Hewlett-Packard Interface Bus 1-1, 9-2, A-1 thru A-8
Hewlett-Packard Graphics Language 1-1, 1-5, 1-6

i

IFC 9-4
IM Instruction 1-14, 6-7, B-6
IN Instruction 1-13, 3-4, 3-6, 8-2, B-6
IP Instruction 2-7, B-6
IW Instruction 2-12, B-7
Immediate Response String 10-16, 10-21, 10-38
Initialize Instruction, IN 1-13, 3-4, 3-6, 8-2, 8-3, B-6
Input Mask Instruction, IM 1-14, 6-7, B-6
Input P1 and P2 Instruction, IP 2-7, B-6
Input Window Instruction, IW 2-12, B-7
Instruction Syntax, HP-GL 1-6
Instruction Syntax, RS-232-C 10-25
Integer Format 1-7
Intercharacter Delay 10-16, 10-18, 10-21, 10-33, 10-38, 10-40, 10-41
Interface Bus Concepts A-1
Interface Clear 9-4

l

LB Instruction 5-7, 8-4, B-7
LT Instruction 4-6, 8-6, 8-7, B-7
Label Fields 1-7, 5-7
Label Instruction, LB 5-7, 8-4, B-7
Label Terminator 5-6, 5-7
Labeling with Variables 5-8, 5-9
Leased Lines Monitoring Mode 10-13
Line Feed 1-6, 5-14, B-1
Line Graphs 1-17, 8-1 thru 8-9
Line Type Instruction, LT 4-6, 8-6, 8-7, B-7
Listener 9-6

m

Mode 1 10-32, 10-33, 10-35
Mode 2 10-32, 10-33
Modem 10-4
Monitor Mode 10-8, 10-11, 10-27, 10-28

Subject Index (Continued)

n

NOP, No Operation Instruction C-7
Normal Mode 10-23

O

OA Instruction 7-2, 8-11, B-8
OC Instruction 7-3, B-8
OD Instruction 6-3, B-8
OE Instruction 7-5, B-8
OF Instruction 7-6, B-9
OH Instruction 2-13, B-9
OI Instruction 7-6, B-9
OO Instruction 7-6, B-9
OP Instruction 2-8, B-10
OS Instruction 6-5, 7-7, B-10
OW Instruction 2-13, B-10
On-line, Programmed Off State 10-6
On-line, Programmed On State 10-3, 10-7, 10-26
Optional Parameters 1-7, 1-8, 10-25
Output Actual Position
 and Pen Status Instruction, OA 7-2, B-8
Output Buffer Size, ESC . L 10-36, B-18
Output Buffer Space Instruction, ESC . B 10-28, 10-29, B-17
Output Commanded Position
 and Pen Status Instruction, OC 7-3, B-8
Output Digitized Point
 and Pen Status Instruction, OD 6-3, B-8
Output Error Instruction, OE 7-5, B-8
Output Extended Error Instruction, ESC . E 10-29, 10-30, B-17, C-6
Output Extended Status Instruction, ESC . O 10-42, 10-43, B-19
Output Factors Instruction, OF 7-6, B-9
Output Hard-clip Limits Instruction, OH 2-13, B-9
Output Identification Instruction, OI 7-6, B-9
Output Initiator Character 10-16, 10-18, 10-21, 10-33, 10-38
Output Options Instruction, OO 7-6, B-9
Output P1 and P2 Instruction, OP 2-8, B-10
Output Status Instruction, OS 6-5, 7-7, B-10
Output Terminator 7-1, 7-2, 10-16, 10-18,
 10-21, 10-22, 10-33, 10-37, 10-38, 10-41
Output Trigger Character 10-15, 10-18, 10-21, 10-22, 10-33, 10-40
Output Window Instruction, OW 2-13, B-10

Subject Index (Continued)

P

| | |
|--|--|
| PA Instruction | 3-1, 3-4 thru 3-8, 8-6, B-11 |
| PD Instruction | 3-2, 3-4 thru 3-8, 8-6, B-11 |
| PR Instruction | 3-1, 3-8, 3-9, 3-10, B-11 |
| PS Instruction | 1-16, B-11 |
| PT Instruction | 3-22, 8-12, 8-15, B-12 |
| PU Instruction | 3-2, 3-4 thru 3-8, 8-6, B-12 |
| P-mask | 1-14, 1-15, 9-5 |
| P1,P2 | 2-5 thru 2-11, 5-12, 5-16, 5-23 thru 5-28, 8-2 |
| Paper Size Instruction, PS | 1-16, B-11 |
| Paper Switch | 2-2, 2-3, 7-3 |
| Parallel Poll | 1-14, 1-15, 9-5, A-1 |
| Parameter Interaction in Labeling Instructions | 5-23 thru 5-28 |
| Pattern Number | 4-6, B-5 |
| Pen Down | 3-2 thru 3-8, 5-19, 5-20, B-11 |
| Pen Instructions, PU and PD | 3-2, 3-4 thru 3-8, 8-7, B-11, B-12 |
| Pen Select Instruction, SP | 3-3, 8-2, 8-12, 8-13, 8-15, B-14 |
| Pen Thickness Instruction, PT | 3-22, 8-12, 8-15, B-12 |
| Pen Up | 3-2, 3-8, 5-21, B-12 |
| Pen Velocity | 1-5, 3-3, 3-4 |
| Personal Computer | 10-2, 10-3 |
| Pie Charts | 1-17, 8-1, 8-13 thru 8-15 |
| Pin Allocations, RS-232-C | 10-11, 10-12 |
| Plot Absolute Instruction, PA | 3-1, 3-4 thru 3-8, 8-6, B-11 |
| Plot Relative Instruction, PR | 3-1, 3-8, 3-9, 3-10, B-11 |
| Plotter Address | 9-2, 9-3, 9-6 |
| Plotter Character Sets | 5-2, C-7 thru C-12 |
| Plotter Environments, RS-232-C | 10-2 thru 10-10 |
| Plotter Instruction Set | 1-5, 1-6, 1-8 |
| Plotter Off Instruction, ESC .) | 10-26, B-17 |
| Plotter On Instruction, ESC . (| 10-26, B-17 |
| Plotter Output | 7-2 |
| Plotter Syntax, 9872 | 1-7, 3-11 |
| Plotter Unit | 2-5 |
| Plotter Unit Equivalent | 3-1, 3-8 |
| Plotting Area | 2-2 |
| Plotting with Variables | 3-10, 8-6 |
| Preparing Your Plotter for Digitizing | 6-2 |

R

| | |
|----------------|------------------------|
| RA Instruction | 3-23, 8-10, 8-12, B-12 |
| RO Instruction | 2-14, B-12 |

Subject Index (Continued)

RR Instruction 3-26, B-13
RS-232-C Interface 1-1, 10-1, 10-10, 10-11, 10-12
RS-232-C Interfacing 10-1 thru 10-12
RS-232-C Plotter Output 7-2
Receiving Data, HP-IB 9-10
Relative Direction Instruction, DR 5-11, 5-24, 5-27, B-3
Relative Plotting 3-1, 3-8, 3-9
Relative Size Instruction, SR 5-17, 5-25 thru 5-28, B-14
Reset Handshake Instruction, ESC . R 10-44, B-19
Rotation Coordinate System Instruction, RO 2-14, B-12

S

SA Instruction 5-4, 5-5, 5-7, B-13
SC Instruction 2-9, 8-2, B-13
SDC 9-4
SI Instruction 5-16, 5-23, B-13
SL Instruction 5-18, B-14
SM Instruction 4-4, 5-29, B-14
SP Instruction 3-3, 8-2, 8-12, 8-13, 8-15, B-14
SR Instruction 5-17, 5-25 thru 5-28, B-14
SS Instruction 5-3, 5-4, 5-7, B-15
S-mask 1-14, 1-15, 6-7
Scaled Decimal Format 1-7
Scale Instruction, SC 2-9, 8-2, B-13
Scaling 2-1, 2-9, 2-10, 2-11, 8-2, C-2
Scaling Points 2-1, 2-5 thru 2-11, 5-17, 5-24 thru 5-28, 8-2
Scaling Without Using the SC Instruction 2-9, 2-10, C-2
Select Alternate Set Instruction, SA 5-4, 5-5, 5-7, B-13
Select Pen Instruction, SP 3-3, 8-2, B-14
Select Standard Set Instruction, SS 5-3, 5-4, 5-7, B-15
Selective Device Clear 9-4
Sending Data, HP-IB 9-7
Serial Poll 6-7, 9-4
Service Request 6-7, 1-14
Set Extended Output and Handshake Mode 10-18, 10-21, 10-32,
10-38, 10-41, 10-44, B-19
Set Handshake Mode 1 Instruction, ESC . H 10-21, 10-22,
10-30, 10-32, 10-44, B-18
Set Handshake Mode 2 Instruction, ESC . I 10-21, 10-22,
10-29, 10-30, 10-33, 10-41, 10-42, 10-44, B-18
Set Output Mode, ESC . M 10-18, 10-21, 10-25,
10-32, 10-37, 10-44, B-19

Subject Index (Continued)

| | |
|--|------------------------------------|
| Set Plotter Configuration Instruction, ESC . @ | 10-8, 10-23, 10-27, 10-44, B-17 |
| Setting the Scaling Points | 2-5 |
| Manually | 2-6 |
| Programmatically | 2-7, 8-2 |
| Setting Up the Plotter, RS-232-C | 10-2 |
| Shade Rectangle Absolute Instruction, RA | 3-23, 8-10, 8-12, B-12 |
| Shade Rectangle Relative Instruction, RR | 3-26, B-13 |
| Shade Wedge Instruction, WG | 3-31, 8-15, B-16 |
| Shift-in | 5-3, 5-4 |
| Shift-out | 5-4, 5-5 |
| Slant Instruction, SL | 5-18, B-14 |
| Software Checking Handshake | 10-15, 10-18, 10-27 |
| Spacing Between Characters | 5-7, 5-13 |
| Stand-alone Environment | 10-3 |
| Standard Character Set | 5-2, 5-3, 5-4 |
| Stop Bits | 10-14 |
| Switched Lines Monitoring Mode | 10-13 |
| Symbol Mode Instruction, SM | 4-4, 4-5, 4-6, B-14 |

t

| | |
|-------------------------------|---|
| TL Instruction | 4-2, B-15 |
| Talker | 9-6 |
| Terminal | 10-4 thru 10-10 |
| Terminal-only Environment | 10-9, 10-10 |
| Terminator | 1-6 thru 1-8 |
| Tick Instructions, XT and YT | 4-2, B-16 |
| Tick Length Instruction, TL | 4-2, 8-3, B-15 |
| Tick Marks | 4-2, 8-3 |
| Transmission Errors, RS-232-C | 10-14 |
| Turnaround Delay | 10-16, 10-18, 10-21, 10-22, 10-33, 10-37, 10-40, 10-41 |

U

| | |
|--|---------------|
| UC Instruction | 5-19, B-15 |
| Unit Systems | 2-5 |
| User Defined Character Instruction, UC | 5-19, B-15 |
| User Units | 2-5, 2-9, 8-2 |
| Using the Plotter with a Computer Mainframe, RS-232-C | 10-2 |

Subject Index (Continued)

Using the Plotter with a Personal Computer,
RS-232-C 10-2
Using the Plotter with a Terminal 10-4, 10-9

V

VS Instruction 3-3, B-15
Velocity Select Instruction, VS 3-3, B-15

W

WG Instruction 3-31, 8-15, B-16
Window 2-1
Window, Outputting the 2-13
 Setting the 2-12

X

XT Instruction 4-2, 8-3, B-16
Xoff Threshold Level 10-17, 10-34, 10-35
Xoff Trigger Character 10-17, 10-20, 10-21, 10-32, 10-35
Xon Trigger Character 10-17, 10-20, 10-21, 10-34
Xon-Xoff Handshake 10-15, 10-20, 10-32 thru 10-35, 10-40

y

YT Instruction 4-2, 8-4, B-16